

MX269023A
LTE TDD Uplink Measurement
Software
Operation Manual
Operation

Sixth Edition

- For safety and warning information, please read this manual before attempting to use the equipment.
- Additional safety and warning information is provided within the MS2690A/MS2691A/MS2692A Signal Analyzer Operation Manual (Mainframe Operation) or MS2830A Signal Analyzer Operation Manual (Mainframe Operation). Please also refer to this document before using the equipment.
- Keep this manual with the equipment.

ANRITSU CORPORATION

Safety Symbols

To prevent the risk of personal injury or loss related to equipment malfunction, Anritsu Corporation uses the following safety symbols to indicate safety-related information. Ensure that you clearly understand the meanings of the symbols BEFORE using the equipment. Some or all of the following symbols may be used on all Anritsu equipment. In addition, there may be other labels attached to products that are not shown in the diagrams in this manual.

Symbols used in manual



DANGER

This indicates a very dangerous procedure that could result in serious injury or death if not performed properly.



WARNING

This indicates a hazardous procedure that could result in serious injury or death if not performed properly.



CAUTION

This indicates a hazardous procedure or danger that could result in light-to-severe injury, or loss related to equipment malfunction, if proper precautions are not taken.

Safety Symbols Used on Equipment and in Manual

The following safety symbols are used inside or on the equipment near operation locations to provide information about safety items and operation precautions. Ensure that you clearly understand the meanings of the symbols and take the necessary precautions BEFORE using the equipment.



This indicates a prohibited operation. The prohibited operation is indicated symbolically in or near the barred circle.



This indicates an obligatory safety precaution. The obligatory operation is indicated symbolically in or near the circle.



This indicates a warning or caution. The contents are indicated symbolically in or near the triangle.



This indicates a note. The contents are described in the box.



These indicate that the marked part should be recycled.

MX269023A
LTE TDD Uplink Measurement Software
Operation Manual Operation

24 June 2011 (First Edition)
20 November 2015 (Sixth Edition)

Copyright © 2011-2015, ANRITSU CORPORATION.

All rights reserved. No part of this manual may be reproduced without the prior written permission of the publisher.

The contents of this manual may be changed without prior notice.

Printed in Japan

Equipment Certificate

Anritsu Corporation guarantees that this equipment was inspected at shipment and meets the published specifications.

Anritsu Warranty

- During the warranty period, Anritsu Corporation will repair or exchange this software free-of-charge if it proves defective when used as described in the operation manual.
- The warranty period is 6 months from the purchase date.
- The warranty period after repair or exchange will remain 6 months from the original purchase date, or 30 days from the date of repair or exchange, depending on whichever is longer.
- This warranty does not cover damage to this software caused by Acts of God, natural disasters, and misuse or mishandling by the customer.

In addition, this warranty is valid only for the original equipment purchaser. It is not transferable if the equipment is resold.

Anritsu Corporation shall assume no liability for injury or financial loss of the customer due to the use of or a failure to be able to use this equipment.

Anritsu Corporation Contact

In the event that this equipment malfunctions, contact an Anritsu Service and Sales office. Contact information can be found on the last page of the printed version of this manual, and is available in a separate file on the CD version.

Notes On Export Management

This product and its manuals may require an Export License/Approval by the Government of the product's country of origin for re-export from your country.

Before re-exporting the product or manuals, please contact us to confirm whether they are export-controlled items or not.

When you dispose of export-controlled items, the products/manuals need to be broken/shredded so as not to be unlawfully used for military purpose.

Software End-User License Agreement (EULA)

Please read this Software End-User License Agreement (hereafter this EULA) carefully before using (includes executing, copying, registering, etc.) this software (includes programs, databases, scenarios, etc., used to operate, set, etc., Anritsu electronic equipment). By reading this EULA and using this software, you are agreeing to be bound by the terms of its contents and Anritsu Corporation (hereafter Anritsu) hereby grants you the right to use this Software with the Anritsu-specified equipment (hereafter Equipment) for the purposes set out in this EULA.

1. Grant of License and Limitations

1. Regardless of whether this Software was purchased from or provided free-of-charge by Anritsu, you agree not to rent, lease, lend, or otherwise distribute this Software to third parties and further agree not to disassemble, recompile, reverse engineer, modify, or create derivative works of this Software.
2. You may make one copy of this Software for backup purposes only.
3. You are not permitted to reverse engineer this software.
4. This EULA allows you to install one copy of this Software on one piece of Equipment.

2. Disclaimers

To the extent not prohibited by law, in no event shall Anritsu be liable for personal injury, or any incidental, special, indirect or consequential damages whatsoever, including, without limitation, damages for loss of profits, loss of data, business interruption or any other commercial damages or losses, arising out of or related to your use or inability to use this Software.

3. Limitation of Liability

- a. If a fault (bug) is discovered in this Software, preventing operation as described in the operation manual or specifications whether or not the customer uses this software as described in the manual, Anritsu shall at its own discretion, fix the bug, or exchange the software, or suggest a workaround, free-of-charge. However, notwithstanding the above, the following items shall be excluded from repair and warranty.
 - i) If this Software is deemed to be used for purposes not described in the operation manual or specifications.
 - ii) If this Software is used in conjunction with other non-Anritsu-approved software.
 - iii) Recovery of lost or damaged data.
 - iv) If this Software or the Equipment has been modified, repaired, or otherwise altered without Anritsu's prior approval.
 - v) For any other reasons out of Anritsu's direct control and responsibility, such as but not limited to, natural disasters, software virus infections, etc.
- b. Expenses incurred for transport, hotel, daily allowance, etc., for on-site repairs by Anritsu engineers necessitated by the above faults shall be borne by you.
- c. The warranty period for faults listed in article 3a above covered by this EULA shall be either 6 months from the date of purchase of this Software or 30 days after the date of repair, whichever is longer.

4. Export Restrictions

You may not use or otherwise export or re-export directly or indirectly this Software except as authorized by Japanese and United States law. In particular, this software may not be exported or re-exported (a) into any Japanese or US embargoed countries or (b) to anyone on the Japanese or US Treasury Department's list of Specially Designated Nationals or the US Department of Commerce Denied Persons List or Entity List. By using this Software, you warrant that you are not located in any such country or on any such list. You also agree that you will not use this Software for any purposes prohibited by Japanese and US law, including, without limitation, the development, design and manufacture or production of missiles or nuclear, chemical or biological weapons of mass destruction.

5. Termination

Anritsu shall deem this EULA terminated if you violate any conditions described herein. This EULA shall also be terminated if the conditions herein cannot be continued for any good reason, such as violation of copyrights, patents, or other laws and ordinances.

6. Reparations

If Anritsu suffers any loss, financial or otherwise, due to your violation of the terms of this EULA, Anritsu shall have the right to seek proportional damages from you.

7. Responsibility after Termination

Upon termination of this EULA in accordance with item 5, you shall cease all use of this Software immediately and shall as directed by Anritsu either destroy or return this Software and any backup copies, full or partial, to Anritsu.

8. Dispute Resolution

If matters of dispute or items not covered by this EULA arise, they shall be resolved by negotiations in good faith between you and Anritsu.

9. Court of Jurisdiction

This EULA shall be interpreted in accordance with Japanese law and any disputes that cannot be resolved by negotiation described in Article 8 shall be settled by the Japanese courts.

Cautions against computer virus infection

- Copying files and data
Only files that have been provided directly from Anritsu or generated using Anritsu equipment should be copied to the instrument.
All other required files should be transferred by means of USB or CompactFlash media after undergoing a thorough virus check.
- Adding software
Do not download or install software that has not been specifically recommended or licensed by Anritsu.
- Network connections
Ensure that the network has sufficient anti-virus security protection in place.

CE Conformity Marking

Anritsu affixes the CE conformity marking on the following product(s) in accordance with the Council Directive 93/68/EEC to indicate that they conform to the EMC and LVD directive of the European Union (EU).

CE marking



1. Product Model

Software: MX269023A LTE TDD Uplink Measurement Software

2. Applied Directive and Standards

When the MX269023A LTE TDD Uplink Measurement Software is installed in the MS2690A/MS2691A/MS2692A or MS2830A, the applied directive and standards of this unit conform to those of the MS2690A/MS2691A/MS2692A or MS2830A main frame.

PS: About main frame

Please contact Anritsu for the latest information on the main frame types that the MX269023A can be used with.

C-Tick Conformity Marking

Anritsu affixes the C-Tick mark on the following product(s) in accordance with the regulation to indicate that they conform to the EMC framework of Australia/New Zealand.

C-Tick marking



1. Product Model

Software: MX269023A LTE TDD Uplink Measurement Software

2. Applied Directive and Standards

When the MX269023A LTE TDD Uplink Measurement Software is installed in the MS2690A/MS2691A/MS2692A or MS2830A, the applied directive and standards of this unit conform to those of the MS2690A/MS2691A/ MS2692A or MS2830A main frame.

PS: About main frame

Please contact Anritsu for the latest information on the main frame types that the MX269023A can be used with.

About This Manual

■ Composition of Operation Manuals

The operation manuals for the MX269023A LTE TDD Uplink Measurement Software are comprised as shown in the figure below.

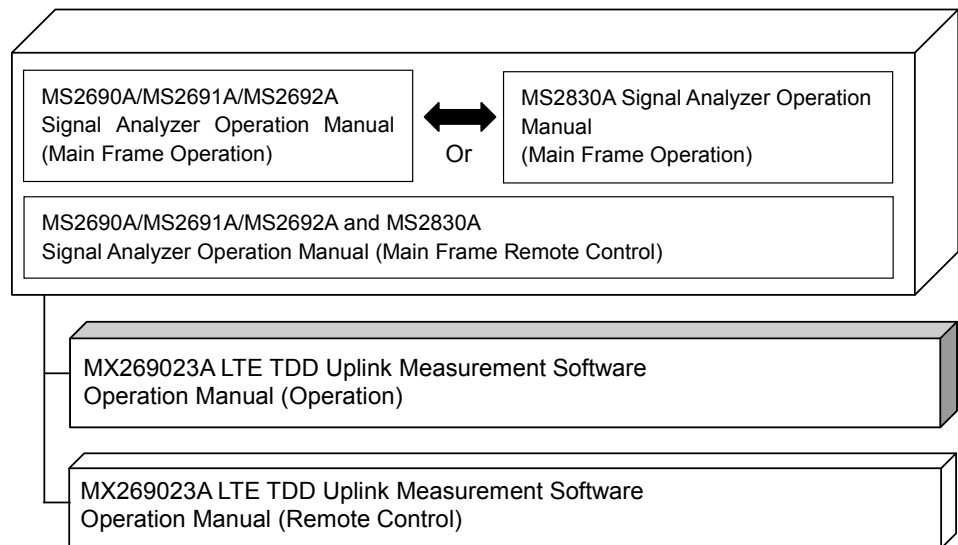

- Signal Analyzer Operation Manual (Mainframe Operation)
- Signal Analyzer Operation Manual (Mainframe Remote Control)

These manuals describe basic operating methods, maintenance procedures, common functions, and common remote control of the signal analyzer mainframe.

- LTE TDD Uplink Measurement Software Operation Manual (Operation)

<This document>

This manual describes basic operating methods, and functions of the LTE TDD Uplink Measurement Software.

- LTE TDD Uplink Measurement Software Operation Manual (Remote Control)

This manual describes remote control of the LTE TDD Uplink Measurement Software.

Convention Used in This Manual

Throughout this document, the use of MS269x Series is assumed unless otherwise specified. If using MS2830A, change MS269xA to read MS2830A.

In this document,  indicates a panel key.

Table of Contents

About This Manual	I
Chapter 1 Overview	1-1
1.1 Product Overview	1-2
1.2 Product Configuration	1-3
1.3 Specifications	1-4
Chapter 2 Preparation	2-1
2.1 Part Names.....	2-2
2.2 Signal Path Setup.....	2-11
2.3 Application Startup and Selection.....	2-12
2.4 Initialization and Calibration	2-13
Chapter 3 Measurement	3-1
3.1 Basic Operation	3-2
3.2 Setting Frequency.....	3-5
3.3 Setting Level.....	3-9
3.4 Capturing IQ Data.....	3-11
3.5 Setting Common Items.....	3-14
3.6 Setting Measurement Items	3-27
3.7 Setting Marker	3-63
3.8 Setting Trigger	3-70
3.9 EVM	3-73
3.10 Constellation.....	3-76
3.11 EVM vs Subcarrier.....	3-79
3.12 EVM vs Symbol	3-81
3.13 Time Based EVM.....	3-83
3.14 EVM vs Demod-Symbol	3-84
3.15 Spectral Flatness	3-85
3.16 In-Band Emission.....	3-87
3.17 Summary	3-89
3.18 Power vs Time Display.....	3-109
3.19 Power vs Time - Burst.....	3-111
3.20 Power vs Time - Transient	3-112
3.21 Saving Measurement Results.....	3-113

Chapter 4 Digitize Function	4-1
4.1 Saving IQ Data	4-2
4.2 Replay Function.....	4-7
Chapter 5 Performance Test.....	5-1
5.1 Overview of Performance Test.....	5-2
5.2 Performance Test Items.....	5-3
Chapter 6 Other Functions	6-1
6.1 Selecting Other Functions.....	6-2
6.2 Setting Title.....	6-2
6.3 Erasing Warmup Message	6-2
Appendix A Error Messages	A-1
Appendix B Default Value List.....	B-1
Index	Index-1

1
2
3
4
5
6
Index

Chapter 1 Overview

This chapter provides an overview of the MX269023A LTE TDD Uplink Measurement Software and describes the product configuration.

1.1	Product Overview.....	1-2
1.2	Product Configuration	1-3
	1.2.1 Standard configuration	1-3
	1.2.2 Option.....	1-3
	1.2.3 Applicable parts	1-3
1.3	Specifications.....	1-4

1.1 Product Overview

The MS2690/MS2691/MS2692A or MS2830A Signal Analyzer enables high-speed, high-accuracy, and simple measurements of transmission characteristics of base stations and mobile stations for various mobile communications types. The MS2690A/MS2691A/MS2692A or MS2830A is equipped with high-performance signal analyzer and spectrum analyzer functions as standard, with optional measurement software allowing modulation analysis functionality supporting various digital modulation modes.

The MX269023A LTE TDD Uplink Measurement Software (hereinafter, referred to as “MX269023A”) is a software option for measuring RF characteristics of LTE (TDD) Uplink specified by 3GPP.

The MX269023A provides the following measurement features.

- Modulation accuracy measurement
- Carrier frequency measurement
- Transmitter power measurement

MS2830A-005/105 and MS2830A-006/106 is required to use the MX269023A on MS2830A.

1.2 Product Configuration

1.2.1 Standard configuration

Table 1.2.1-1 lists the standard configuration of the MX269023A.

Table 1.2.1-1 Standard configuration

Item	Model Name/Symbol	Product Name	Q'ty	Remarks
Application	MX269023A	LTE TDD Uplink Measurement Software	1	
Accessory	—	Installation CD-ROM	1	Application software, operation manual CD-ROM

1.2.2 Option

Tables 1.2.2-1 list the option for the MX269023A. This is sold separately.

Table 1.2.2-1 Option

Option No.	Product Name	Remarks
MX269023A-001	LTE-Advanced TDD Uplink Measurement Software	

1.2.3 Applicable parts

Table 1.2.3-1 lists the applicable parts for the MX269023A.

Table 1.2.3-1 Applicable parts

Model Name /Symbol	Product Name	Remarks
W3521AE	MX269023A LTE TDD Uplink Measurement Software Operation Manual (Operation)	English, printed version
W3522AE	MX269023A LTE TDD Uplink Measurement Software Operation Manual (Remote Control)	English, printed version

1.3 Specifications

Table 1.3-1 shows the specifications for the MX269023A.

When MS2830A is used, this software's specification is specified by the condition below, unless otherwise noted.

Attenuator Mode: Mechanical Atten Only

Table 1.3-1 Specifications

Item	Specification
Common Specifications	
Channel bandwidth	1.4, 3, 5, 10, 15, 20 MHz
Target signal	Uplink
Span setting	The LTE-Advanced is selectable when MX269023A-001 is installed. When LTE is selected: Span=31.25 MHz fixed When LTE-Advanced is selected, and when Option 077/177/078/178 is not installed: Span=31.25 MHz When LTE-Advanced is selected, and when Option 077/177 is installed: Span = 62.5 MHz When LTE-Advanced is selected, and when Option 078/178 is installed: Span = 125 MHz
Capture Time	The condition “When Span = 62.5 MHz and 125 MHz” is applied when MX269023A-001 is installed. •When Span = 31.25 MHz Capture Time = Auto: 5 Frame Capture Time = Manual: 5 to 150 Frame •When Span=62.5 MHz Capture Time = Auto: 5 Frame Capture Time = Manual: 5 to 100 Frame •When Span=125 MHz Capture Time = Auto: 5 Frame Capture Time = Manual: 5 to 50 Frame
Modulation/Frequency Measurement	
Measurement frequency ranges	MS269x Series: 400 to 5000 MHz MS2830A: 400 to 5000 MHz MS2830A-040: 400 to 3600 MHz
Measurement level range	MS269x Series : -15 to +30 dBm (at Pre-Amp Off, or Pre-Amp not installed.) -15 to +10 dBm (at Pre-Amp On) MS2830A : -15 to +30 dBm (at Pre-Amp Off, or Pre-Amp not installed.)

Table 1.3-1 Specifications (Continued)

Item	Specification
Carrier frequency accuracy	After CAL execution at 18 to 28°C For a PUSCH signal of EVM = 1% and Full RB For Measurement Interval = 10 Subframe MS269x Series : $\pm(\text{accuracy of reference frequency} \times \text{carrier frequency} + 8 \text{ Hz})$ MS2830A : $\pm(\text{accuracy of reference frequency} \times \text{carrier frequency} + 8 \text{ Hz})$ (At the input level is -4 dBm when MS2830A-045 is installed)
Residual EVM	After CAL execution at 18 to 28°C For Measurement Interval = 10 Subframe The condition “When Span = 62.5 MHz or 125MHz” is applied when MX269023A-001 is installed. MS269x Series: <1.0% (rms) (When Span = 31.25 MHz) <1.3% (rms) (When Span = 62.5 MHz or 125MHz) MS2830A: <1.2% (rms) (When Span = 31.25 MHz) <1.3% (rms) (When Span = 62.5 MHz or 125MHz) (At the input level is -4 dBm when MS2830A-045 is installed)
Transmitter power accuracy	After CAL execution, input attenuator ≥ 10 dB, at 18 to 28°C, the input signal measured is within the measurement level range and below the value set in Input Level, when Span = 31.25 MHz. MS269x Series: ± 0.6 dB (at Pre-Amp Off, or Pre-Amp not installed.) ± 1.1 dB (at Pre-Amp On) MS2830A: ± 0.6 dB (at Pre-Amp Off, or Pre-Amp not installed.) Transmitter power accuracy is calculated from an RSS (root summed square) error of the absolute amplitude accuracy and the in-band frequency characteristics of the MS2690A/MS2691A/MS2692A or MS2830A.
Measurement target channel signal	Measurement target channel When LTE is selected: PUSCH, PUCCH, PRACH When LTE-Advanced is selected: PUSCH, PUCCH Measures and displays the result per channel. The channel setting is mutually exclusive.

Table 1.3-1 Specifications (Continued)

Item	Specification
Waveform display	Provides functions for displaying waveforms below. Constellation EVM vs Subcarrier EVM vs Symbol Time Based EVM EVM vs Demod-Symbol Spectral Flatness In-Band Emission Power vs Time
Adjacent Channel Power Measurement	
Measurement method	Executes the adjacent channel power measurement function of the Spectrum Analyzer or Signal Analyzer.
Occupied Bandwidth Measurement	
Measurement method	Executes the occupied bandwidth measurement function of the Spectrum Analyzer or Signal Analyzer.
Channel Power Measurement	
Measurement method	Executes the channel power measurement function of the Spectrum Analyzer or Signal Analyzer.
Spectrum Emission Mask Measurement	
Measurement method	Executes the spectrum emission mask measurement function of the Spectrum Analyzer.
Digitize function	
	Capable of outputting captured waveform data to internal hard disk or external hard disk
Waveform data	Format: I, Q (32 bit floating point binary format) Level: Assumes as $\sqrt{I^2 + Q^2} = 1$ for 0 dBm input Level accuracy: Same as the absolute amplitude accuracy and in-band frequency characteristics of the signal analyzer.
Replay Function	
	Analyzes traces of saved waveform data Format: I, Q (32 bit floating point binary format) Sampling rate: The condition “When Span = 62.5 MHz or 125 MHz” is applied when MX269023A-001 is installed. 50 MHz (When Span = 31.25 MHz) 100 MHz (When Span = 62.5 MHz) 200 MHz (When Span = 125 MHz)
Component Carrier (CC) allocated condition	
Maximum number of CCs	2
Channel bandwidth of each CC	1.4, 3, 5, 10, 15, 20 MHz
Frequency offset range of each CC	-(Span – Channel bandwidth of each CC)/2 to (Span – Channel bandwidth of each CC)/2

Chapter 2 Preparation

This chapter describes the preparations required for using the application you are using. Refer to the *MS2690A/MS2691A/MS2692A Signal Analyzer Operation Manual (Mainframe Operation)* or *MS2830A Signal Analyzer Operation Manual (Mainframe Operation)* for common features not included in this manual.

2.1	Part Names	2-2
	2.1.1 Front panel	2-2
	2.1.2 Rear panel	2-8
2.2	Signal Path Setup	2-11
2.3	Application Startup and Selection.....	2-12
	2.3.1 Launching application.....	2-12
	2.3.2 Selecting application.....	2-12
2.4	Initialization and Calibration.....	2-13
	2.4.1 Initialization.....	2-13
	2.4.2 Calibration	2-13

2.1 Part Names

This section describes the panel keys for operating the instrument and connectors used to connect external devices. For general points of caution, refer to the *MS2690A/MS2691A/MS2692A Signal Analyzer Operation Manual (Mainframe Operation)* or *MS2830A Signal Analyzer Operation Manual (Mainframe Operation)*.

2.1.1 Front panel

This section describes the front-panel keys and connectors.

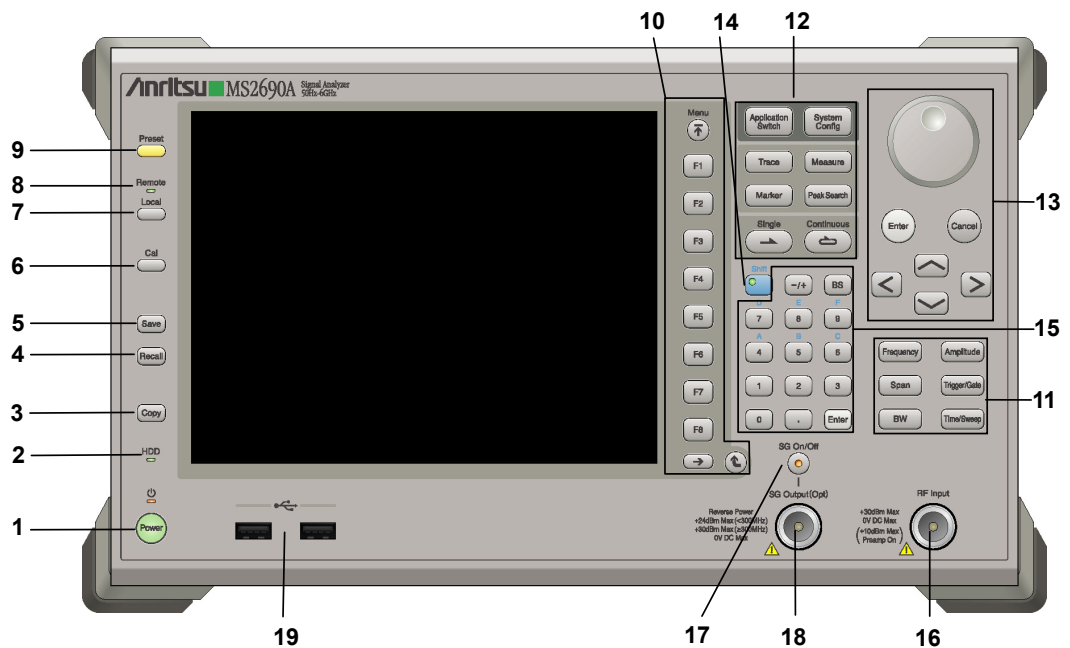

Figure 2.1.1-1 MS269x series front panel

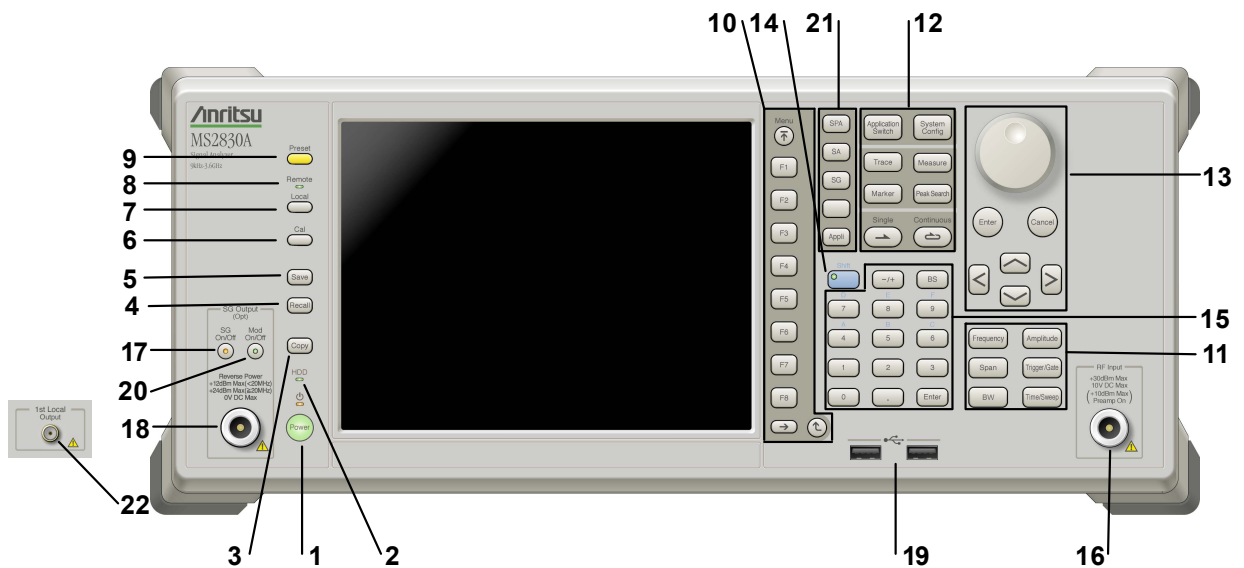
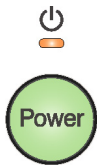







Figure 2.1.1-2 MS2830A front panel

- 1  **Power Switch**
Press to switch between the standby state (AC power supplied) and power-on state. The Power lamp  lights orange at Standby and green at Power On. Press the power switch for about 2 seconds.
- 2  **Hard disk access lamp**
Lights when accessing the internal hard disk.
- 3  **Copy key**
Press to capture display screen and save to file.
- 4  **Recall key**
Press to recall parameter file.
- 5  **Save key**
Press to save parameter file.
- 6  **Cal key**
Press to display the Calibration menu.



Local key

Press to return to local operation from remote control via GPIB, Ethernet, or USB (B), and enable panel settings.



Remote lamp

Lights when in remote-control state.



Preset key

Resets parameters to initial settings.



10



Function keys

Selects or configures function menu displayed on the right of the screen. The function menu is provided in multiple pages and layers.

Press  to fetch next function menu page. The current page number is displayed at the bottom of the function menu, as in “1 of 2”.

Sub-menus may be displayed when a function menu is pressed. Press  to go back to the previous menu. Press  to go back to the top menu.

11





Main function keys 1

Press to set or execute main functions.

Executable functions vary with the current application. When nothing happens with the press, it indicates that the application in use does not support the key.

 Press to set frequency parameters.

 Press to set level parameters.

 No function is assigned to this key.

 Press to set trigger parameters.

 No function is assigned to this key.

 Press to set measurement item parameters.

12





Main function keys 2

Press to set or execute main functions.

Executable functions vary with the current application. When nothing happens with the press, it indicates that the application in use does not support the key.

 Press to switch application.

 Press to display Configuration screen.

 Press to set the trace items or to switch the operation window.

 Press to set measurement item parameters.

 Use when switching graph marker operation.

 Press to set parameters related to the peak search function.

 Press to start single measurement.

 Press to start continuous measurements.

13

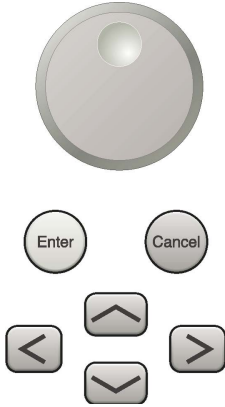

Rotary knob/Cursor key/Enter key/Cancel key

The rotary knob and cursor keys select display items or change settings.

Press  to set the entered or selected data.

Press  to cancel input or selected data.

14



Shift key

Operates keys with functions in blue characters on panel. Press the Shift key so the key lamp is green and then press the target key.

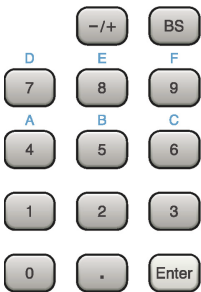

15



Numeric keypad

Enters numbers on parameter setup screens.

Press  to delete the last entered digit or character.

[A] to [F] can be entered by pressing keys  to  while the Shift key lamp  is green.

16

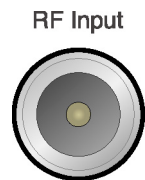

RF Input connector

Inputs RF signal. This is an N type input connector.

17



RF Output Control key

Press  to switch on/off the modulation of RF signal when the Vector Signal Generator option is installed. The RF output control key lamp lights orange when the RF signal output is set to On.

This is not available when the Option 044/045 is installed. (Only for MS2830A)

18 SG Output(Opt)



RF Output connector (when Option 020 installed)

Outputs RF signal, when the Vector Signal Generator option is installed. This is an N type output connector.

This is not available when the Option 044/045 is installed. (Only for MS2830A)

19

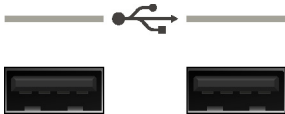

USB connector (type A)

Connect the accessory USB keyboard, mouse or USB memory.

20



Modulation control key (MS2830A only)

Press to switch on/off the modulation of RF signal when the Vector Signal Generator option is installed. The lamp  on the key lights up in green in the modulation On state.

This is not available when the Option 044/045 is installed.

21



Application key (MS2830A only)

Press to switch between applications.



Press to display the Spectrum Analyzer main screen.



Press to display the Signal Analyzer main screen, when Option 005/105 and 006/106 are installed.



Press to display the Signal Generator main screen, when Vector Signal Generator option is installed.



This is a blank key. Not used.



Displays the main screen of the application that is selected using the Application Switch (Auto), or displays that of the pre-selected application (Manual).

For details, refer to 3.5.4 “Changing application layout” in *MS2830A Signal Analyzer Operation Manual (Mainframe Operation)*.

22



1st Local Output connector (Only for MS2830A)

This is available when the Option 044/045 is installed.

Supplies local signal and bias current to the external mixer, and receives the IF signal with its frequency converted.

2.1.2 Rear panel

This section describes the rear-panel connectors.

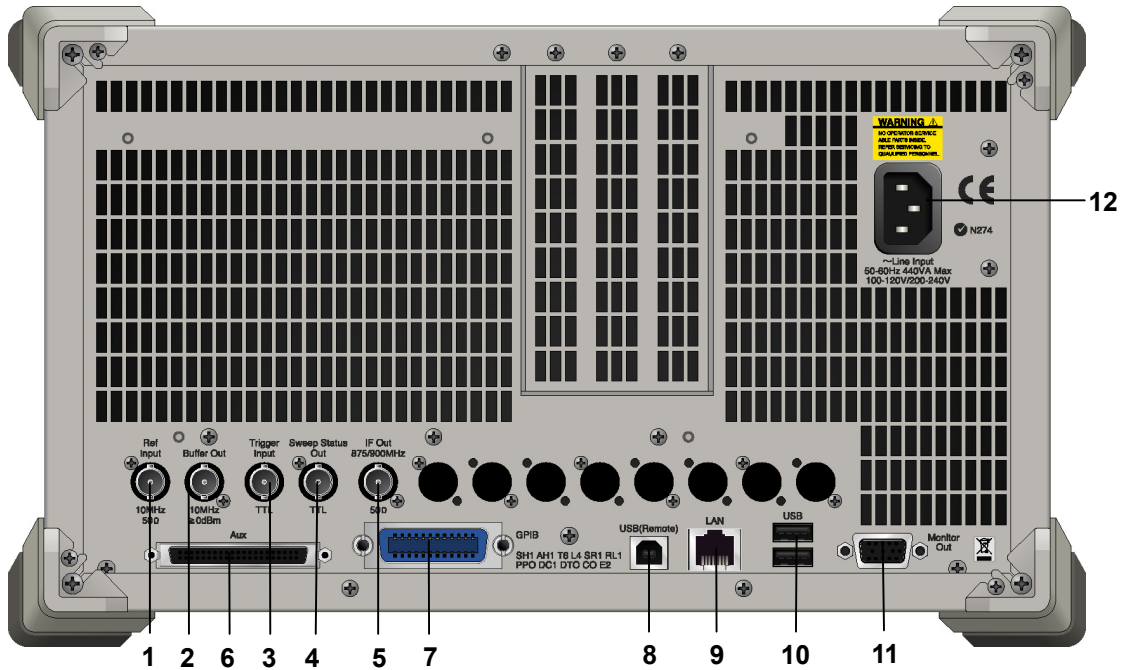

Figure 2.1.2-1 MS269x series rear panel

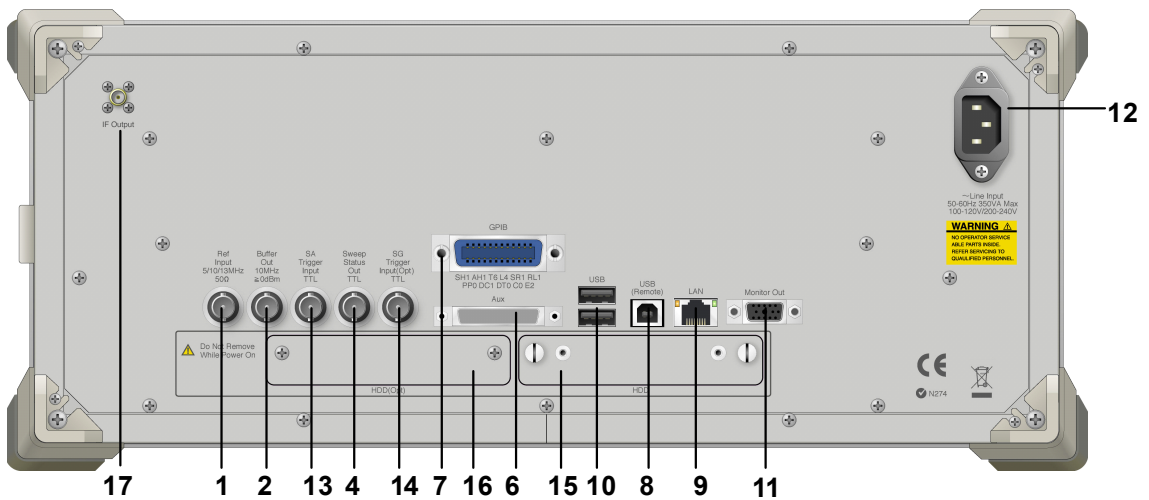





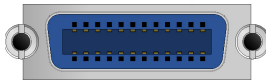











Figure 2.1.2-2 MS2830A rear panel

- | | | |
|---|---|---|
| 1 |  <p style="text-align: center;">Ref
Input</p> | <p>Ref Input connector (reference frequency signal input connector)</p> <p>Inputs external reference frequency signal. It is for inputting reference frequency signals with higher accuracy than the instrument's internal reference signal, or for synchronizing the frequency of the MS2690A/MS2691A/MS2692A or MS2830A to that of other equipment. The following frequencies are supported:</p> <p>MS269x series: 10 MHz/13 MHz
MS2830A: 5 MHz/10 MHz/13 MHz</p> |
| 2 |  <p style="text-align: center;">Buffer Out</p> | <p>Buffer Out connector (reference frequency signal output connector)</p> <p>Outputs the internal reference frequency signal (10 MHz). It is for synchronizing frequencies between other equipment and the MS2690A/MS2691A/MS2692A or MS2830A.</p> |
| 3 |  <p style="text-align: center;">Trigger
Input</p> | <p>Trigger Input connector (MS269x series only)</p> <p>Inputs trigger signal from external device.</p> |
| 4 |  <p style="text-align: center;">Sweep Status
Out</p> | <p>Sweep Status Out connector</p> <p>Outputs signal when internal measurement is performed or measurement data is obtained.</p> |
| 5 |  <p style="text-align: center;">IF Out
875/900MHz</p> | <p>IF Out connector (MS269x series only)</p> <p>Not used.</p> |
| 6 |  <p style="text-align: center;">Aux</p> | <p>AUX connector</p> <p>Not used.</p> |
| 7 |  <p style="text-align: center;">GP-IB</p> | <p>GP-IB connector</p> <p>For external control via GPIB.</p> |
| 8 |  <p style="text-align: center;">USB(Remote)</p> | <p>USB connector (type B)</p> <p>For external control via USB.</p> |

Chapter 2 Preparation

- 9** **LAN**
 Ethernet connector
Connects PC or Ethernet network.
- 10** **USB**

 USB connector (type A)
Used to connect a USB keyboard or mouse or the USB memory supplied.
- 11** **Monitor Out**
 Monitor Out connector
Connects external display.
- 12**

~Line Input
50-60Hz 440VA Max
100-120V/200-240V
AC inlet
Supplies power.
- 13** **SA
Trigger
Input
TTL**
 SA Trigger Input connector (MS2830A only)
This is a BNC connector for inputting external trigger signal (TTL) for SPA and SA applications.
- 14** **SG
Trigger
Input(Opt)
TTL**
 SG Trigger Input connector (MS2830A only)
This is a BNC connector for inputting external trigger signal (TTL) for Vector Signal Generator option.
- 15** **HDD**
HDD slot (MS2830A only)
This is a standard hard disk slot.
- 16** **HDD(Opt)**
HDD slot for Option (MS2830A only)
This is a hard disk slot for the options.
- 17**  IF output connector (Only for MS2830A)
Monitor output of the internal IF signal.
This is available when the Option 044/045 is installed.

2.2 Signal Path Setup

As shown in Figure 2.2-1, connect the instrument and the DUT using an RF cable, so that the signal to be tested is input to the RF Input connector. To prevent an excessive level signal from being input, do not input the signal before setting the input level using this application.

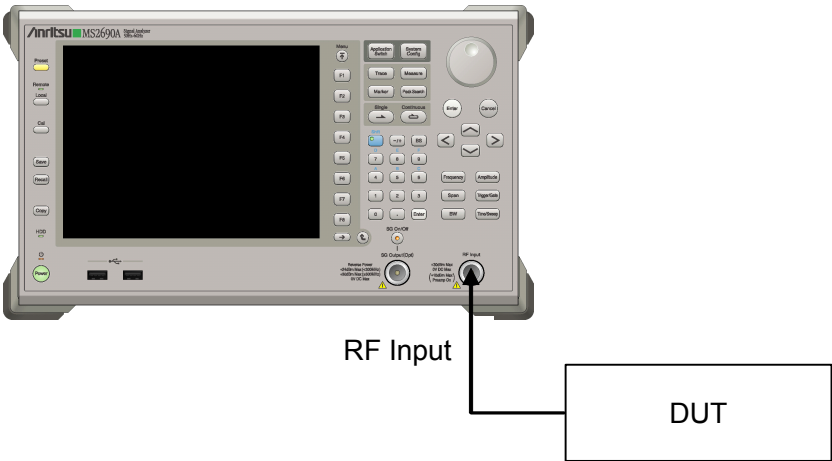

Figure 2.2-1 Signal path setup example

Set the reference signal and/or trigger signal paths from external sources, as required.

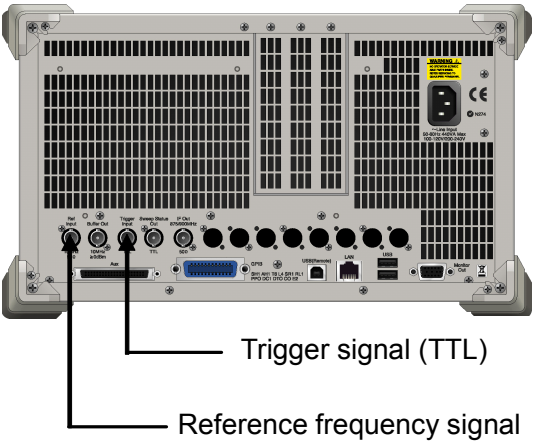

Figure 2.2-2 External signal input

2.3 Application Startup and Selection

To use this application, it is necessary to load (start up) and select the application.





2.3.1 Launching application

The application startup procedure is described below.

Note:

The XXX indicates the application name currently in use.

<Procedure>

1. Press  to display the Configuration screen.
2. Press  (Application Switch Settings) to display the Application Switch Registration screen.
3. Press  (Load Application Select), and move the cursor to “XXX” in the **Unloaded Applications** list.
If “XXX” is displayed in the **Loaded Applications** list, this means that the application is already loaded.
If “XXX” appears in neither the **Loaded Applications** nor **Unloaded Applications** list, this means that the application has not been installed.
4. Press  (Set) to load the application. If “XXX” is displayed in the **Loaded Applications** list, this means that the application is already loaded.

2.3.2 Selecting application

The selection procedure is described below.

<Procedure>

1. Press  to display the Application Switch menu.
2. Press the menu function key displaying “XXX”.

The application can also be selected with mouse, by clicking “XXX” on the task bar.

2.4 Initialization and Calibration

This section describes the parameter settings and the preparations required before starting measurement.

2.4.1 Initialization



After selecting this application, first perform initialization. Initialization returns the settable parameters to their default value in order to clear the measurement status and measurement results.

Note:

When another software application is switched to or this application is unloaded (ended), the application keeps the parameter settings at that time. The parameter values that were last set will be applied when this application is selected next time.

The initialization procedure is as follows.

<Procedure>

1. Press  to display the Preset function menu.
2. Press  (Preset).

2.4.2 Calibration

Perform calibration before performing measurement. Calibration sets the level accuracy frequency characteristics for the input level to flat, and adjusts level accuracy deviation caused by internal temperature fluctuations. Calibration should be performed when first performing measurement after turning on power, or if beginning measurement when there is a difference in ambient temperature from the last time calibration was performed.

<Procedure>

1. Press  to display the Application Cal function menu.
2. Press  (SIGANA All).

For details on calibration functionality only executable with this instrument, refer to the *MS2690A/MS2691A/MS2692A Signal Analyzer Operation Manual (Mainframe Operation)* or *MS2830A Signal Analyzer Operation Manual (Mainframe Operation)*.

Chapter 3 Measurement

This section describes the measurement function, the parameter contents and the setting methods for this application.

3.1	Basic Operation	3-2
3.1.1	Screen layout.....	3-2
3.1.2	Function menu.....	3-3
3.1.3	Performing measurement.....	3-4
3.2	Setting Frequency.....	3-5
3.2.1	Operating Band	3-7
3.3	Setting Level	3-9
3.4	Capturing IQ Data	3-11
3.4.1	Setting capture time.....	3-12
3.4.2	Averaging IQ data.....	3-12
3.5	Setting Common Items	3-14
3.5.1	Demodulation Reference Signal (PUSCH).....	3-20
3.5.2	Demodulation Reference Signal (PUCCH)	3-22
3.5.3	PRACH	3-25
3.6	Setting Measurement Items.....	3-27
3.6.1	Modulation analysis	3-28
3.6.2	Power vs Time	3-53
3.6.3	Adjacent Channel Power Measurement (ACP).....	3-60
3.6.4	Channel Power Measurement (Channel Power).....	3-61
3.6.5	Occupied Bandwidth Measurement (OBW) ...	3-62
3.6.6	Spectrum Emission Mask Measurement (SEM)	3-62
3.7	Setting Marker.....	3-63
3.8	Setting Trigger	3-70
3.9	EVM Display	3-73
3.10	Constellation	3-76
3.11	EVM vs Subcarrier.....	3-79
3.12	EVM vs Symbol.....	3-81
3.13	Time Based EVM.....	3-83
3.14	EVM vs Demod-Symbol.....	3-84
3.15	Spectral Flatness	3-85
3.16	In-Band Emission.....	3-87
3.17	Summary.....	3-89
3.18	Power vs Time Display	3-109
3.19	Power vs Time - Burst	3-111
3.20	Power vs Time - Transient.....	3-112
3.21	Saving Measurement Results.....	3-113

3.1 Basic Operation

3.1.1 Screen layout

This section describes the screen layout of this application.

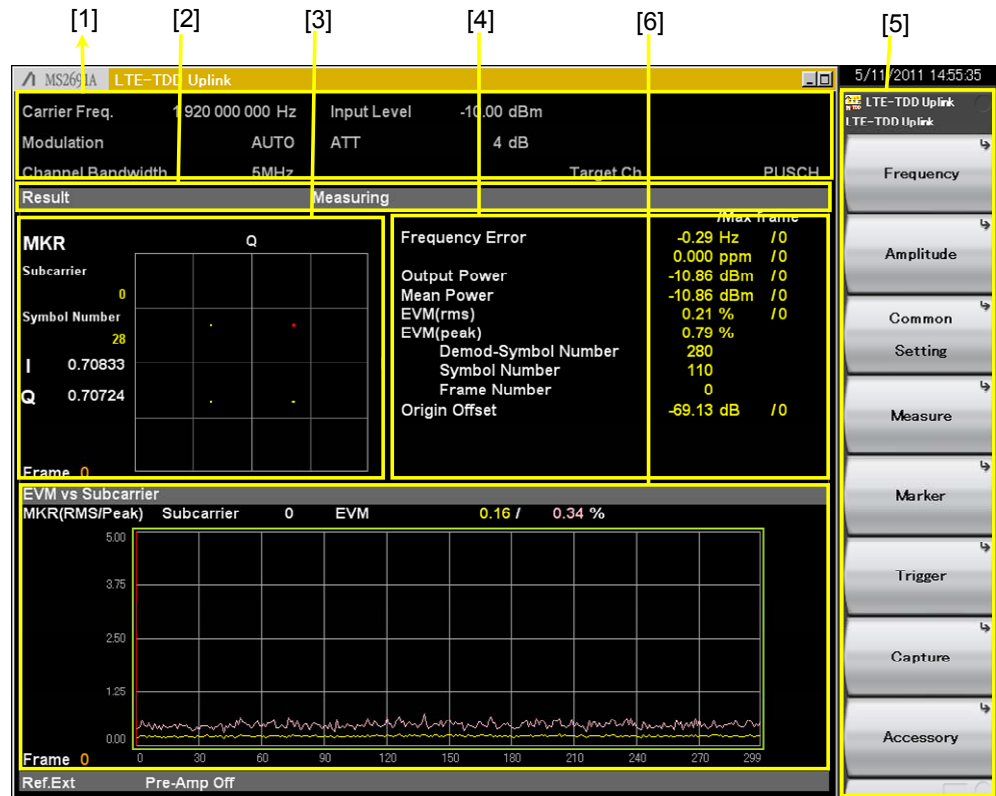

Figure 3.1.1-1 Screen layout

- [1] Measurement parameter
Displays the specified parameter.
- [2] Status message
Displays signal status.
- [3] Constellation
Displays the constellation of the selected symbol.
- [4] Result window
Displays the measurement results.
- [5] Function menu
Displays the functions executable with function keys.
- [6] Graph window
Displays the graph of the measurement results.

3.1.2 Function menu

This section describes the main function menu on the main screen.

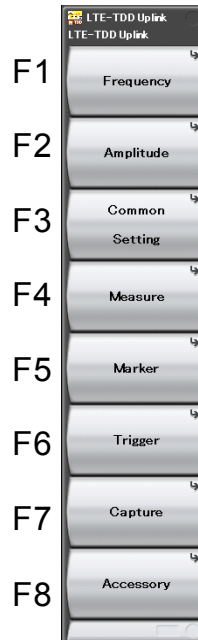

Figure 3.1.2-1 Main function menu

Table 3.1.2-1 Main function menu

Function Keys	Menu Display	Function
F1	Frequency	Sets a frequency 3.2 "Setting Frequency"
F2	Amplitude	Sets a level. 3.3 "Setting Level"
F3	Common Setting	Sets common items. 3.5 "Setting Common Items"
F4	Measure	Sets measurement items. 3.6 "Setting Measurement Items"
F5	Marker	Sets a marker. 3.7 "Setting Marker"
F6	Trigger	Sets a trigger. 3.8 "Setting Trigger"
F7	Capture	Configures a setting for IQ data capture. 3.4 "Capturing IQ Data"
F8	Accessory	Performs settings for other functions. 6.1 "Selecting Other Functions"

3.1.3 Performing measurement

There are two measurement modes: single and continuous. Measurement is performed once in the single measurement mode, and continuously in the continuous measurement mode.

Single Measurement

After capturing an input signal based upon the settings of Capture Time, the selected measurement items are measured only for the measurement count (Storage Count) before measurement is stopped.

<Procedure>

1. Press .

Continuous Measurement

Following capture of an input signal based on the settings of Capture Time, the selected measurement items are continuously measured for the measurement count (Storage Count), and this procedure is repeated. Measurement will continue even if parameters are changed or the window display is changed. Measurement will be stopped if another application is selected or if the Replay function is executed.

<Procedure>



1. Press .

Note:

The two measurement modes are not available when the Replay function is executed. For the Replay function, analysis starts when the IQ data file is specified.

 4.2 “Replay Function”

3.2 Setting Frequency

Configures settings related to frequency. Pressing  (Frequency) on the main function menu displays the Frequency function menu. Pressing  displays the Frequency function menu and opens the Carrier Frequency dialog box.

Note:

You cannot set a frequency when the Replay function is executed.

Table 3.2-1 Frequency function menu

Function Keys	Menu Display	Function
F1	Carrier Frequency	Sets the Carrier Frequency
F2	E-UTRA Operating Band	Display the E-UTRA Operating Band function menu.  3.2.1 "Operating Band"
F3	Span	Sets the Frequency Span.

Carrier Frequency

■ Summary

Sets a carrier frequency.

■ Setting range

300 MHz to the upper limit of the main unit
(When MS2830A-077/177/078/178 is installed.)
100 MHz to the upper limit of the main unit
(MS269xA, MS2830A other than above.)

E-UTRA Operating Band

■ Summary

Displays E-UTRA Operating Band function menu.

 3.2.1 "Operating Band"

This setting is used to calculate the Spectral Flatness measurement result displayed on the Summary screen.

 3.17 "Summary"

Span

■ Summary

Sets the Frequency Span.

■ Options

Auto Judges automatically from Freq. Offset and Channel Bandwidth of each CC.

31.25 MHz Captures with the Span fixed to 31.25 MHz.

62.5 MHz Captures with the Span fixed to 62.5 MHz.
(When MS269xA-004/104/077/177/078/178 or MS2830A-077/177/078/178 is installed.)

125 MHz Captures with the Span fixed to 125 MHz.
(When MS269xA-004/104/078/178 or MS2830A-078/178 is installed.)

Note:

When Standard is LTE, the Span is fixed to 31.25 MHz and cannot be edited. During replay, Span is fixed and cannot be edited.

The maximum span is defined as below.

31.25MHz When neither MS269xA-004/104/077/177/078/178 nor MS2830A-077/177/078/178 is installed.

62.5MHz When neither MS269xA-004/104/078/178 nor MS2830A-078/178 is installed and when MS269xA-077/177 or MS2830A-077/177 is installed.

125MHz When MS269xA-004/104/078/178 or MS2830A-078/178 is installed.

Table 3.2-2 E-UTRA Operating Band and the F_{UL_low} and F_{UL_high} settings

E-UTRA Operating Band	Lower limit frequency (F_{UL_low}) [MHz]	Higher limit frequency (F_{UL_high}) [MHz]
0	Minimum Carrier Frequency – Maximum Span/2	Minimum Carrier Frequency + Maximum Span/2
33	1900	1920
34	2010	2025
35	1850	1910
36	1930	1990
37	1910	1930
38	2570	2620
39	1880	1920
40	2300	2400
41	2496	2690

3.2.1 Operating Band

Sets E-UTRA Operating Band. Pressing  (E-UTRA Operating Band) on the Frequency function menu displays the E-UTRA Operating Band function menu.

Table 3.2.1-1 E-UTRA Operating Band function menu

Function Keys	Menu Display	Function
F1	Operating Band Setting	Sets how to set the Operating Band.
F2	Operating Band Number	Sets the Band Number when Operating Band Setting is Standard.
F3	Operating Band Lowest Frequency	Sets the lowest frequency when Operating Band Setting is User.
F4	Operating Band Highest Frequency	Sets the highest frequency when Operating Band Setting is User.

Operating Band Setting

■ Summary

For the operating band, selects either “Standard” set by the band number or “User” set by the highest and lowest frequency of user setting.

■ Options

Standard Uses the Operating Band setting.
User Uses the User setting.

Operating Band Number

■ Summary

Sets the band number when the Operating Band Setting is “Standard”.

■ Setting Range

0, 33 to 41

■ Details

Table 3.2-2 shows how the lower limit frequency (F_{UL_low}) and upper limit frequency (F_{UL_high}) are specified for each transmission frequency band corresponding to the E-UTRA Operating Band setting.

Operating Band Lowest Frequency

■ Summary

Sets the lowest frequency when Operating Band Setting is set to User.

■ Setting Range

Minimum Carrier Frequency-Maximum Span / 2
to Maximum Carrier Frequency+Maximum Span / 2

Note:

The value can be set as long as Highest Frequency is bigger than Lowest Frequency.

Operating Band Highest Frequency

■ Summary

Sets the highest frequency when Operating Band Setting is set to User.

■ Setting Range

Minimum Carrier Frequency-Maximum Span / 2
to Maximum Carrier Frequency+Maximum Span / 2

Note:

The value can be set as long as Highest Frequency is bigger than Lowest Frequency.

3.3 Setting Level

Configures settings related to level. Pressing **F2** (Amplitude) on the main function menu displays the Amplitude function menu. Pressing **Amplitude** displays the Amplitude function menu and opens the Input Level dialog box.

Note:

You cannot set a level when the Replay function is executed.

Table 3.3-1 Amplitude function menu

Function Keys	Menu Display	Function
F1	Input Level	Sets the input level from the target DUT.
F2	Lowest ATT Setting	Sets the lowest ATT setting to 0/4/10 dB.
F4	Pre-Amp	Turns the Pre-Amp function On/Off.
F7	Offset	This turns on/off the Offset function.
F8	Offset Value	This sets the level correction coefficient.

Input Level

■ Summary

Sets the input level from the target DUT.

■ Setting range

For Pre-Amp: On

(-80.00 + Offset Value) to (10.00 + Offset Value) dBm

For Pre-Amp: Off:

(-60.00 + Offset Value) to (30.00 + Offset Value) dBm

Lowest ATT Setting

■ Summary

Sets the lowest ATT setting to 0 dB, 4 dB or 10 dB.

■ Options

0 dB The lowest ATT setting is 0 dB.

4 dB The lowest ATT setting is 4 dB.

10 dB The lowest ATT setting is 10 dB.

Pre-Amp

■ Summary

Turns the Pre-Amp function On/Off.

■ Options

On Enables the Pre-Amp function.

Off Disables the Pre-Amp function.

Offset

■ Summary

This turns on/off the Offset function.

■ Options

- On Enables the offset function.
- Off Disables the offset function.

Offset Value

■ Summary

This sets the level correction coefficient.

■ Setting range

-99.99 to 99.99 dB

■ Setting example

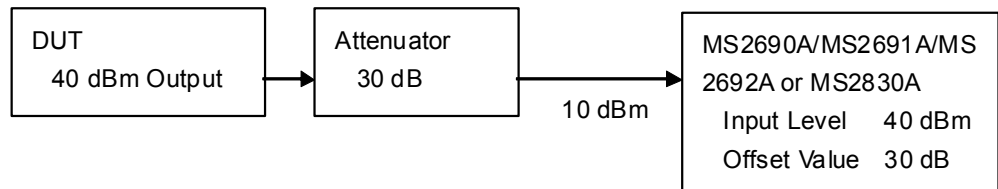

Figure 3.3-1 Input level and offset level setting example

3.4 Capturing IQ Data

This section describes the settings of IQ data.





Pressing  (Capture) on the main function menu displays the Capture function menu.

Table 3.4-1 Capture function menu

Function Keys	Menu Display	Function
F1	Capture Time Auto/Manual	Switches between the two capture modes of IQ data (auto setting and manual setting).
F2	Capture Time Length	Sets the capture time length of IQ data.
F3	Save Captured Data	Saves the captured IQ data.  Chapter 4 “Digitize Function”
F4	Replay	Replays the captured IQ data.  Chapter 4 “Digitize Function”
F5	Stop Replaying	Stops replaying the captured IQ data.  Chapter 4 “Digitize Function”

Capture Time

■ Summary

Switches between the two capture modes of IQ data (auto setting and manual setting).

■ Options

Auto, Manual

Note:

This is not available when the Replay function is executed.

Capture Time Length

■ Summary

Sets the capture time length of IQ data.

■ Setting range

5 to 150	Span=31.25 MHz
5 to 100	Span=62.5 MHz
5 to 50	Span=125 MHz

Note:

When Span is Auto, the Span is set to the value displayed on the screen.

(When Standard is LTE, the Span is fixed to 31.25 MHz)

This is not available when the Replay function is executed.

3.4.1 Setting capture time

Sets the capture mode from Capture Time and the capture time length from Capture Time Length.

Capture Time

Auto The data necessary to measure five frame for each one measurements is always captured. The Auto mode is set by default for this application.

Manual In this mode, the number of frames measured for each measurement can be specified.

Capture Time Length

Set the number of frames per one measurement. The frames in the interval specified for Capture Time Length must always be continuous. If Capture Time Length is specified, the Manual mode is automatically used.

When measuring ACP, Channel Power, and OBW using the Replay function, save the IQ data in the Manual mode.

3.4.2 Averaging IQ data

The averaging method differs according to the capture time mode.

Auto

In the Auto mode, capture of five frame starts at the trigger timing. After the measurement is completed, capture of another frame starts at the next trigger timing. The average and maximum values are calculated from the measurement results at each storage count. The frames of multiple measurements are not necessarily consecutive.

The storage count and the capture count are the same in single measurement. In continuous measurement, the average and maximum values are calculated from the last data of the storage count after measurement has been performed the number of times corresponding to the storage count.

Manual

In the Manual mode, if measurement starts at the trigger timing, frames are continuously captured for the number specified by Capture Time Length. After each frame measurement, the average and maximum values are calculated from the measurement results at each storage count.

In single measurement, the storage count is reached at each capture. In continuous measurement, the single measurement operation is performed repeatedly.

In the Manual mode, the maximum Storage Count always depends on the maximum capture time length and the measurement items. (Refer to the description of “Storage Count” in Section 3.6.1.3 or 3.6.2.1.)

3.5 Setting Common Items





This section describes the settings for the common items. Pressing  (Common Setting) on the main function menu displays the Common Setting function menu.

Table 3.5-1 Common setting

Function Keys	Menu Display	Function
Page 1		
F1	Standard	Switches the measurement standard (LTE / LTE-Advanced).
F2	Contiguous Mode	Switches the Contiguous Mode.
F3	Target Channel	Sets the measurement target channel.
F4	Number of CCs	Sets the number of CCs to measure.
F5	Synchronization CC#	Sets CC# as a target of frame synchronization.
F6	Setting/ Result Target CC#	Selects a target CC# for parameter setting and measurement result display in measurement items for individual CC.
F7	In-Band Em. Carr. Leak Freq.	Sets the position of carrier leak frequency in LTE-Advanced In-band emission measurement.
Page 2		
F1	CC Status	Displayed when PUSCH or PUCCH is selected with Target Channel. Switches On and Off the selected CC.
F2	CC Frequency Offset	Displayed when PUSCH or PUCCH is selected with Target Channel. Sets Frequency Offset of the selected CC against Carrier Frequency.
F3	Channel Bandwidth	Sets BW channel, the bandwidth of input signal.
F4	Uplink-downlink configuration	Specifies Uplink-downlink configuration to be measured.
F5	Special subframe configuration	Specifies Special subframe configuration of signal to be measured.
F7	PRACH	Displayed when PRACH is selected with Target Channel. Sets the channel parameters when Target Channel is set to PRACH.  3.5.3 "PRACH"
	Demodulation Reference Signal	Displayed when PUSCH or PUCCH is selected with Target Channel. Sets the Demodulation Reference Signal (DMRS) parameters of the channel set with Target Channel.  3.5.1 "Demodulation Reference Signal (PUSCH)"  3.5.2 "Demodulation Reference Signal (PUCCH)"

Standard**■ Summary**

Switches the measurement standards between LTE and LTE-Advanced.

■ Options

LTE, LTE-A

Note:

This is unavailable when the MX269023A-001 LTE-Advanced TDD Uplink Measurement Software is not installed.

During replay, the standards can be switched only when Span is 31.25MHz.

Contiguous Mode**■ Summary**

Sets Contiguous Mode to On and Off.

■ Options

On	Sets Contiguous Mode to On.
Off	Sets Contiguous Mode to Off.

Note:

This is not available when Standard is set to LTE.

Target Channel**■ Summary**

Sets Channel to be measured.

■ Options

Selects a channel to be measured from PUSCH, PUCCH, and PRACH by setting Include or Exclude.

Incl	The channel is measured.
Excl	The channel is not measured.

Note:

Because the specified channel settings are mutually exclusive, measurement using a mixed signal is not possible. In addition, measurement for each Channel is performed on a single UE basis and cannot be performed with multiple UEs.

PRACH cannot be selected when Standard is LTE-A

Number of CCs

■ Summary

Sets the number of CCs to measure.

■ Options

1, 2

Note:

This is not available when Standard is set to LTE.

Synchronization CC#

■ Summary

Sets CC# as a target of frame synchronization.

■ Options

CC#0 Performs frame synchronization only for CC#0.

CC#1 Performs frame synchronization only for CC#1.

Each CC Performs frame synchronization for each CC.

Note:

This is not available when Standard is set to LTE.

Each CC cannot be selected when Contiguous Mode is On.

CC#1 cannot be selected when Number of CCs is 1.

Setting/Result Target CC#

■ Summary

Selects a target CC# for parameter setting and measurement results display in measurement items for individual CC.

■ Options

0 CC#0 is a target for parameter setting and measurement results display.

1 CC#1 is a target for parameter setting and measurement results display.

Note:

This is not available when Standard is set to LTE.

CC#1 cannot be selected when Number of CCs is 1.

In-Band Em. Carr. Leak Freq.**■ Summary**

Sets the position of carrier leak frequency in LTE-Advanced In-band emission measurement.

■ Options**At Carrier Frequency**

Sets carrier leak frequency to Carrier Frequency.

At Each CC Center

Sets carrier leak frequency to center frequency of each CC.

Note:

This is not available when Standard is set to LTE.

The setting is unavailable when both CC Status (CC#0 Status and CC#1 Status) are On.

CC Status**■ Summary**

Switches On and Off the selected CC at Setting/Result Target CC#.

■ Options

On The CC selected by Setting/Result Target CC# is regarded as Allocated.

Off The CC selected by Setting/Result Target CC# is regarded as Non-allocated.

Note:

This is not available when Standard is set to LTE.

CC Frequency Offset

■ Summary

Sets Frequency Offset of the selected CC against Carrier Frequency.

■ Setting Range

–(Span – Channel Bandwidth / 2)
to +(Span – Channel Bandwidth / 2) Hz

Note:

This is not available when Standard is set to LTE.
When Contiguous Mode is On, Frequency Offset between CC#0 and #1 is limited to the multiples of 300 kHz.
When Frequency Span is Auto, the above setting range is set according to the maximum span.
When Frequency Span is Auto, the span is automatically set as below.

- 31.25 MHz The case where the absolute value of CC Edge frequency that is farthest from the center frequency is 15.625 MHz or below.
- 62.5 MHz The case where the absolute value of CC Edge frequency that is farthest from the center frequency is 31.25 MHz and that does not correspond to the above.
- 125 MHz The case that does not correspond to the above.

Channel Bandwidth

■ Summary

Sets BW channel, the bandwidth of input signal.

■ Options

- 1.4 MHz Analyzes an input signal as a 1.4-MHz band.
- 3 MHz Analyzes an input signal as a 3-MHz band.
- 5 MHz Analyzes an input signal as a 5-MHz band.
- 10 MHz Analyzes an input signal as a 10-MHz band.
- 15 MHz Analyzes an input signal as a 15-MHz band.
- 20 MHz Analyzes an input signal as a 20-MHz band.

Uplink-downlink configuration

■ Summary

Specifies Uplink-downlink Configuration of signal to be measured.

■ Setting range

0 to 6

Special subframe configuration

■ Summary

Specifies Special subframe configuration of signal to be measured.

■ Setting range

0 to 8

PRACH

■ Summary

Displayed when PRACH is selected with Target Channel.

Sets the channel parameters when Target Channel is set to PRACH.

Demodulation Reference Signal (DMRS)

■ Summary

Sets the DMRS parameter for the specified Target Channel.

3.5.1 Demodulation Reference Signal (PUSCH)

Sets the Demodulation Reference Signal parameters when Target Channel is set to the PUSCH channel.

Pressing  (Demodulation Reference Signal) on page 2 of the Common Setting function menu displays the DMRS Parameter function menu.

Table 3.5.1-1 DMRS Parameters Auto Function Menu

Function Keys	Menu Display	Function
F1	Cell ID	Sets the Cell ID value.
F2	n_DMRS_2	Sets the N_DMRS_2 value.
F3	n_DMRS_1	Sets the N_DMRS_1 value.
F4	Delta SS	Sets the Delta SS value.
F6	Sequence Hopping	Switches Sequence Hopping ON/OFF.
F7	Group Hopping	Switches Group Hopping ON/OFF.
F8	PUSCH Subframe Assignment	Sets the presence of Subframe 0 to 9.

Cell ID

■ Summary

Sets the Cell ID.

■ Setting range

0 to 503

n_DMRS_2

■ Summary

Sets n_DMRS_2.

■ Options

0, 2, 3, 4, 6, 8, 9, 10

n_DMRS_1

■ Summary

Sets n_DMRS_1.

■ Options

0, 2, 3, 4, 6, 8, 9, 10

Delta SS

■ Summary

Sets Delta SS.

■ Setting range

0 to 29

Sequence Hopping

■ Summary

Switches Sequence Hopping ON/OFF.

Note:

If the Group Hopping setting is switched to ON while this parameter setting is ON, the Sequence Hopping setting automatically becomes OFF.

Group Hopping

■ Summary

Switches Group Hopping ON/OFF.

Note:

If the Sequence Hopping setting is switched to ON while this parameter setting is ON, the Group Hopping setting automatically becomes OFF.

PUSCH Subframe Assignment

■ Summary

Sets the PUSCH Subframe Assignment for each SubFrame from 0 to 9.

■ Options

On, Off

3.5.2 Demodulation Reference Signal (PUCCH)

Sets the Demodulation Reference Signal parameters when Target Channel is set to the PUCCH channel. Pressing **F7** (Demodulation Reference Signal) on page 2 of the Common Setting function menu displays the DMRS Parameter function menu.

Table 3.5.2-1 DMRS Parameters Auto Function Menu

Function Keys	Menu Display	Function
Page 1		
F1	Cell ID	Sets the Cell ID value.
F2	N_cs_1	Sets the N_cs_1 value.
F3	N_RB_2	Sets the N_RB_2 value.
F4	n_PUCCH_1	Sets the n_PUCCH_1 value.
F5	n_PUCCH_2	Sets the n_PUCCH_2 value.
F6	n_PUCCH_3	Sets the n_PUCCH_3 value.
F7	Delta Shift PUCCH	Sets the Delta Shift PUCCH value.
F8	PUCCH Subframe Assignment	Sets the presence of Subframe 0 to 9.
Page 2		
F7	Group Hopping	Switches Group Hopping ON/OFF.

Cell ID

■ **Summary**

Sets the Cell ID.

■ **Setting range**

0 to 503

N_cs_1

■ **Summary**

Sets N_cs_1.

■ **Settings**

0 to 7

N_RB_2**■ Summary**

Sets N_RB_2.

■ Setting range

0 (or 1*) to 98	Channel Bandwidth: 20 MHz
0 (or 1*) to 74	Channel Bandwidth: 15 MHz
0 (or 1*) to 49	Channel Bandwidth: 10 MHz
0 (or 1*) to 24	Channel Bandwidth: 5 MHz
0 (or 1*) to 14	Channel Bandwidth: 3 MHz
0 (or 1*) to 5	Channel Bandwidth: 1.4 MHz

* When N_cs_1 = 0, the minimum value is 1.

n_PUCCH_1**■ Summary**

Sets n_PUCCH_1 for subframes 0 to 9.

■ Setting range

0 to 7199	Channel Bandwidth: 20 MHz
0 to 5399	Channel Bandwidth: 15 MHz
0 to 3599	Channel Bandwidth: 10 MHz
0 to 1799	Channel Bandwidth: 5 MHz
0 to 1079	Channel Bandwidth: 3 MHz
0 to 431	Channel Bandwidth: 1.4 MHz

n_PUCCH_2**■ Summary**

Sets n_PUCCH_2.

■ Setting range

Minimum value 0

Maximum value Defined with the following formula:

$$n_{\text{PUCCH}}^{(2)} < N_{\text{RB}}^{(2)} \times 12 + \left\lceil \frac{N_{\text{cs}}^{(1)}}{8} \right\rceil \cdot (12 - N_{\text{cs}}^{(1)} - 2)$$

n_PUCCH_3

■ Summary

Sets n_PUCCH_3.

■ Setting range

0 to 499 Channel Bandwidth: 20 MHz

0 to 374 Channel Bandwidth: 15 MHz

0 to 249 Channel Bandwidth: 10 MHz

0 to 124 Channel Bandwidth: 5 MHz

0 to 74 Channel Bandwidth: 3 MHz

0 to 29 Channel Bandwidth: 1.4 MHz

Note:

This is available only when PUCCH Format is 3.

Delta Shift PUCCH

■ Summary

Sets Delta Shift PUCCH.

■ Setting range

1 to 3

PUCCH-Subframe Assignment

■ Summary

Sets the PUCCH Subframe Assignment for each SubFrame from 0 to 9.

■ Options

On, Off

Group Hopping

■ Summary

Switches Group Hopping ON/OFF.

3.5.3 PRACH

Sets the channel parameters when Target Channel is set to PRACH.

Pressing  (PRACH) on page 2 of the Common Setting function menu displays the PRACH function menu.

Table 3.5.3-1 PRACH Function menu

Function Keys	Menu Display	Function
F1	Configuration Index	Sets the Configuration Index value.
F2	Physical Root Sequence Number Index	Sets the Physical Root Sequence Number Index value.
F3	Cyclic Shift Value	Sets the cyclic shift value.

Configuration Index

■ Summary

Sets the Configuration Index value.

■ Setting range

0 to 57

Note:

The Preamble Format value switches according to this parameter setting.

Table 3.5.3-2 Preamble Format Values

Configuration Index	Preamble Format
0 to 19	0
20 to 29	1
30 to 39	2
40 to 47	3
48 to 57	4

It cannot be set within the range in the table below depending on the setting value of Uplink-Downlink Configuration.

Table 3.5.3-3 Uplink-downlink Configuration and Out of Setting range

Uplink-downlink Configuration	Out of Setting range
0	11, 19
1	8, 13, 14, 40 to 47
2	5, 7, 8, 11, 13, 14, 17, 19 to 47
3	10, 11, 19, 22, 24, 32, 34, 42, 44, 50, 52
4	5, 7, 8, 11, 13, 14, 17, 19, 22, 24, 32, 34, 40 to 47, 50, 52
5	2, 4, 5, 7, 8, 10, 11, 13, 14, 16, 17, 19 to 47, 50, 52
6	16, 17, 42, 44

Physical Root Sequence Number Index

■ Summary

Sets Physical Root Sequence Number Index.

■ Setting range

1 to 838: Configuration Index 0 to 47

1 to 138: Configuration Index 48 to 57

Cyclic Shift Value

■ Summary

Sets Cyclic Shift Value.

■ Setting range

0 to 838: Configuration Index 0 to 47

0 to 138: Configuration Index 48 to 57

3.6 Setting Measurement Items















Sets measurement items. Pressing  (Measure) on the main function menu or pressing  displays the Measure function menu.

Table 3.6-1 Measure Function Menu

Function Keys	Menu Display	Function
Page 1		
F1	Modulation Analysis	Sets Modulation Analysis.  3.6.1 "Modulation Analysis"
F2	Power vs Time	Sets Power vs Time.  3.6.2 "Power vs Time"
F3	ACP (FFT)	Calls the ACP function of the Signal Analyzer function.  3.6.3 "Adjacent Channel Power Measurement (ACP)"
F4	ACP (Swept)	Calls the ACP function of the Spectrum Analyzer function.  3.6.3 "Adjacent Channel Power Measurement (ACP)"
F5	ChannelPower (FFT)	Calls the Channel Power function of the Signal Analyzer function.  3.6.4 "Channel Power Measurement (Channel Power)"
F6	ChannelPower (Swept)	Calls the Channel Power function of the Spectrum Analyzer function.  3.6.4 "Channel Power Measurement (Channel Power)"
F7	OBW (FFT)	Calls the OBW function of the Signal Analyzer function.  3.6.5 "Occupied Bandwidth Measurement (OBW)"
F8	OBW (Swept)	Calls the OBW function of the Spectrum Analyzer function.  3.6.5 "Occupied Bandwidth Measurement (OBW)"
Page 2		
F1	Modulation Analysis	Same as  on page 1.  3.6.1 "Modulation Analysis"
F2	Power vs Time	Same as  on page 1  3.6.2 "Power vs Time"
F5	Spectrum Emission Mask (Swept)	Recalls the Spectrum Emission Mask function of the Spectrum Analyzer function.  3.6.6 "Spectrum Emission Mask Measurement (SEM)"

3.6.1 Modulation analysis

Sets Modulation Analysis. Pressing **F1** (Modulation Analysis) on the Measure function menu displays the Modulation Analysis function menu.

The menu screen for the Modulation Analysis function menu depends on the channel set with Target Channel on the Common Setting function menu. Press **→** to display the second page.

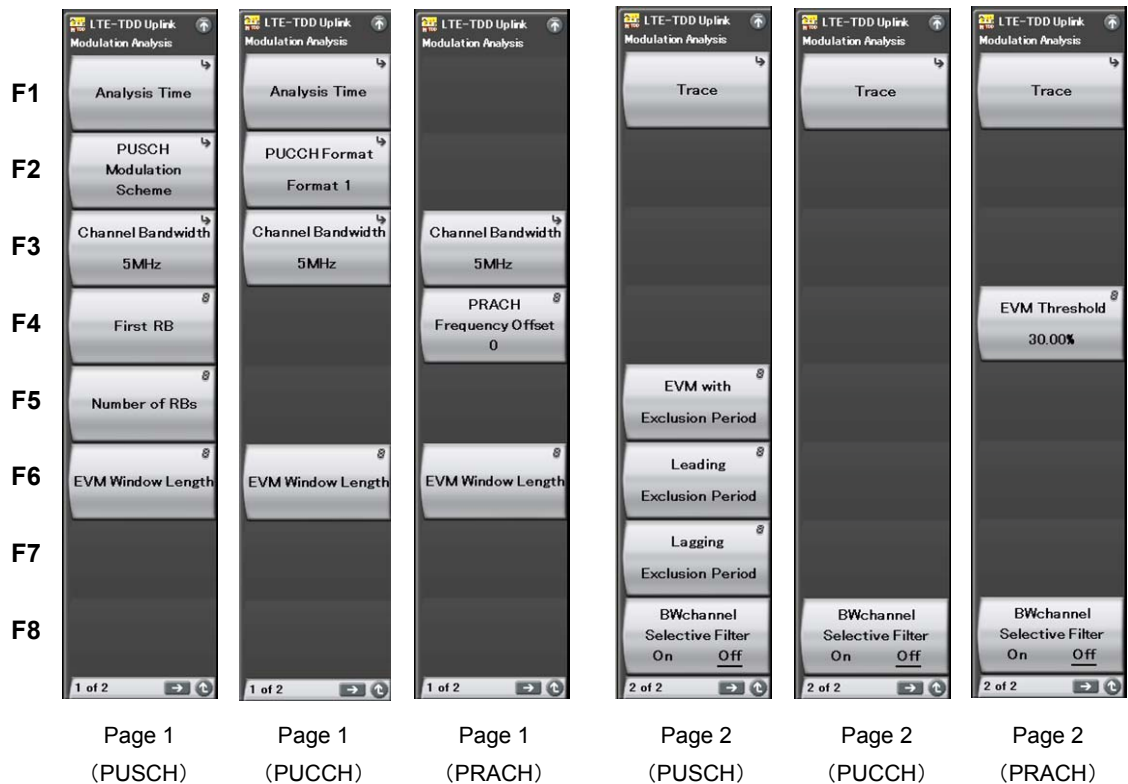





Figure 3.6.1-1 Modulation Analysis Function Menu

Table 3.6.1-1 Modulation Analysis Function Menu

Function Keys	Menu Display	Function
Page 1		
F1	Analysis Time	Sets measurement position.  3.6.1.1 “Analysis Time”
F2	PUSCH Modulation Scheme	This command sets the PUSCH Modulation Scheme.
	PUCCH Format	Sets PUCCH Format.
F3	Channel Bandwidth	Sets Channel Bandwidth.  3.5 “Setting Common Items”
F4	First RB	Sets first RB number of transmitted RBs.
	PRACH Frequency Offset	Sets the frequency position of the PRACH signal.
F5	Number of RBs	Sets number of transmitted RBs.
F6	EVM Window Length	Sets the FFT window length.
Page 2		
F1	trace	Sets the trace.  3.6.1.2 “Trace (other than Summary)”
F4	EVM Threshold	When the measured EVM (rms) exceeds the set value while measuring PRACH, the measurement result status is judged as Signal Abnormal .
F5	EVM with Exclusion Period	Sets whether to include the rising interval of slot separation to the EVM calculation.
F6	Leading Exclusion Period	Sets the EVM measurement excluded interval length of front part of all Subframes on PUSCH measurement.
F7	Lagging Exclusion Period	Sets the EVM measurement excluded interval length of rear part of all Subframes on PUSCH measurement.
F8	BWchannel Selective Filter	Set this function to isolate signals out of the transmission band.

PUSCH Modulation Scheme

■ Summary

This command sets the PUSCH Modulation Scheme.

■ Options

QPSK	Analyzes an input signal as a QPSK modulated signal.
16QAM	Analyzes an input signal as a 16QAM modulated signal.
64QAM	Analyzes an input signal as a 64QAM modulated signal.
AUTO	Analyzes an input signal after judging its modulation scheme automatically.

Note:

The menu is displayed and the settings can be specified only when Target Channel is set to PUSCH.

PUCCH Format

■ Summary

Sets PUCCH Format.

■ Options

1	Sets PUCCH Format to 1 (N/A).
1a	Sets PUCCH Format to 1a (BPSK).
1b	Sets PUCCH Format to 1b (QPSK).
2	Sets PUCCH Format to 2 (QPSK).
2a	Sets PUCCH Format to 2a (QPSK+BPSK).
2b	Sets PUCCH Format to 2b (QPSK+QPSK).
3	Sets PUCCH Format to 3 (QPSK).

Note:

The menu is displayed and the settings can be specified only when Target Channel is set to PUCCH.

Format 3 is unavailable when Standard is LTE.

First RB**■ Summary**

Sets first RB number of transmitted RBs, when the Target Channel is PUSCH. Sets for each SubFrame from 0 to 9 individually.

■ Setting range

0 to 99	Channel Bandwidth: 20 MHz
0 to 74	Channel Bandwidth: 15 MHz
0 to 49	Channel Bandwidth: 10 MHz
0 to 24	Channel Bandwidth: 5 MHz
0 to 14	Channel Bandwidth: 3 MHz
0 to 5	Channel Bandwidth: 1.4 MHz

 3.5 “Setting Common Items”

Note:

The menu is displayed and the settings can be specified only when Target Channel is set to PUSCH.

When the Target Channel is PUSCH, Subframe0 to 9 can be set collectively by specifying a value for All Subframe.

PRACH Frequency Offset**■ Summary**

Sets the frequency position of the PRACH signal. The unit is RB.

■ Setting range

0 to 94	Channel Bandwidth: 20 MHz
0 to 69	Channel Bandwidth: 15 MHz
0 to 44	Channel Bandwidth: 10 MHz
0 to 19	Channel Bandwidth: 5 MHz
0 to 9	Channel Bandwidth: 3 MHz
0	Channel Bandwidth: 1.4 MHz

 3.5 “Setting Common Items”

Note:

The menu is displayed and the settings can be specified only when Target Channel is set to PRACH.

Number Of RBs

■ Summary

Sets number of transmitted RBs.

■ Setting range

1 to (100–FirstRBNumber)	Channel Bandwidth: 20 MHz
1 to (75–FirstRBNumber)	Channel Bandwidth: 15 MHz
1 to (50–FirstRBNumber)	Channel Bandwidth: 10 MHz
1 to (25–FirstRBNumber)	Channel Bandwidth: 5 MHz
1 to (15–FirstRBNumber)	Channel Bandwidth: 3 MHz
1 to (6–FirstRBNumber)	Channel Bandwidth: 1.4 MHz

 3.5 “Setting Common Items”

Note:

The menu is displayed and the settings can be specified only when Target Channel is set to PUSCH.

EVM Window Length (When Target Channel is other than PRACH)

■ Summary

This command sets the FFT window length. There are two setting methods: Ts and W.

If the channel bandwidth is changed, the setting is restored to the default value according to the changed channel bandwidth. (See Table 3.6.1-2.)

■ Setting range

Ts :	0 to 142	
W :	0 to 8	Channel Bandwidth: 1.4 MHz
	0 to 17	Channel Bandwidth: 3 MHz
	0 to 35	Channel Bandwidth: 5 MHz
	0 to 71	Channel Bandwidth: 10 MHz
	0 to 106	Channel Bandwidth: 15 MHz
	0 to 142	Channel Bandwidth: 20 MHz

 3.5 “Setting Common Items”

Table 3.6.1-2 Default value of Channel Bandwidth and EVM Window Length

Channel Bandwidth	EVM Window Length (W)	Conversion from W to Ts
1.4 MHz	5	×16
3 MHz	12	×8
5 MHz	32	×4
10 MHz	66	×2
15 MHz	102	× (2048 / 1536)
20 MHz	136	×1

EVM Window Length (Target Channel=PRACH)

■ Summary

This command sets the FFT window length. The Ts and W setting methods are available, but both result in the same value. Note that the setting range varies according to the PRACH Configuration Index value (described in 3.5 "Setting Common Items").

■ Setting range

Ts(W):	PRACH Configuration Index: 0 to 19	0 to 3166
	PRACH Configuration Index: 20 to 29	0 to 21022
	PRACH Configuration Index: 30 to 39	0 to 6238
	PRACH Configuration Index: 40 to 47	0 to 21022
	PRACH Configuration Index: 48 to 57	0 to 446

EVM Threshold

■ Summary

When the measured EVM (rms) exceeds the set value while measuring PRACH, the measurement result status is judged as Signal Abnormal.

■ Setting range

0.00 to 100.00 Resolution 0.01%

EVM with Exclusion Period

■ Summary

Changes the EVM measurement length and sets whether to include the rising and falling interval of slot separation to the EVM calculation. Sets for each SubFrame from 0 to 9 individually.

■ Options

On Included in EVM calculation.
Off Not included in EVM calculation.

Note:

The menu is displayed and the settings can be specified only when Target Channel is set to PUSCH.

Leading Exclusion Period

■ Summary

Sets the EVM measurement excluded interval length of front part of all Subframes on PUSCH measurement. Sets for each SubFrame from 0 to 9 individually.

■ Setting range

0 to 70 μ s Resolution 10 ns

Note:

The menu is displayed and the settings can be specified only when Target Channel is set to PUSCH.

Lagging Exclusion Period

■ Summary

Sets the EVM measurement excluded interval length of rear part of all Subframes on PUSCH measurement. Sets for each SubFrame from 0 to 9 individually.

■ Setting range

0 to 70 μ s Resolution 10 ns

Note:

The menu is displayed and the settings can be specified only when Target Channel is set to PUSCH.

BWchannel Selective Filter

■ Summary

Sets the band filter On and Off.

■ Options

On The filter is used.
Off The filter is not used.

3.6.1.1 Analysis Time

Sets measurement position. Pressing **F1** (Analysis Time) on page 1 of the Modulation Analysis function menu or **Time/Sweep** displays the Analysis Time function menu. However, this menu key is only valid if Target Channel is not set to PRACH.

This application captures data based on the value specified by Capture Time Length, and synchronizes the data in frame units. Also, it analyzes the data in subframe/slot units, and then displays the results. Specify the position to start synchronization for the captured data by using the Analysis Frame Position parameters. Specify the position to start analysis based on the synchronization point by using the Starting Subframe/Slot Number parameter. Specify the analysis length by using the Measurement Interval parameter.

Even if the Measurement Interval setting is 2 or more, measurement is performed using a measurement signal for which the channel maps for each subframe are regarded as common.

Table 3.6.1.1-1 Analysis Time Function Menu

Function Keys	Menu Display	Function
F1	Starting Subframe Number	Sets the analysis starting number in subframe or slot units.
	Starting Slot Number	
F2	Measurement Interval	Sets the analysis length in subframe or slot units.
F3	Measurement Interval Resolution	Sets the unit of the analysis starting number and analysis length with F1 and F2 keys.
F7	Analysis Frame Position	This sets the analysis starting number in frame units.

Starting Subframe Number

Starting Slot Number

■ Summary

This sets the analysis starting number in subframe or slot units.

■ Setting range

It can be set within the range in the table below depending on the setting value of Uplink-Downlink Configuration.

Table 3.6.1.1-2 Uplink-downlink Configuration, Starting Subframe Number and Starting Slot Number

Uplink-downlink Configuration	Setting range	
	Starting Subframe Number (Measurement Interval Resolution = Subframe) N = 0 to 4	Starting Slot Number (Measurement Interval Resolution = Slot) N = 0 to 4
0	(2, 3, 4, 7, 8, 9) + 10×N	(5, 6, 7, 8, 9, 15, 16, 17, 18, 19) + 20×N
1	(2, 3, 7, 8) + 10×N	(5, 6, 7, 15, 16, 17) + 20×N
2	(2, 7) + 10×N	(5, 15) + 20×N
3	(2, 3, 4) + 10×N	(5, 6, 7, 8, 9) + 20×N
4	(2, 3) + 10×N	(5, 6, 7) + 20×N
5	(2) + 10×N	(5) + 20×N
6	(2, 3, 4, 7, 8) + 10×N	(5, 6, 7, 8, 9, 15, 16, 17) + 20×N

Measurement Interval

■ Summary

This sets the analysis length in subframe or slot units. Every measured value is averaged in Measurement Interval.

■ Setting range

When Measurement Interval Resolution = Subframe:

1 to (50 – Starting Subframe Number)

When Measurement Interval Resolution = Slot:

1 to (100 – Starting Slot Number)

Measurement Interval Resolution

■ Summary

This sets the unit of the analysis starting number and analysis length with F1 and F2 keys.

■ Options

Subframe

Subframe is used for units.

The analysis target is all Uplink subframes within the analysis length.

Slot

Slot is used for units.

The analysis target is the Uplink slots within the analysis length except the slots right after the special subframes. (This complies with Annex E.1 General in 3GPP TS 36.521-1.)

The following figure shows a setting example of each resolution when Uplink-Downlink Configuration is set to 1 (D S U U D D S U U D).

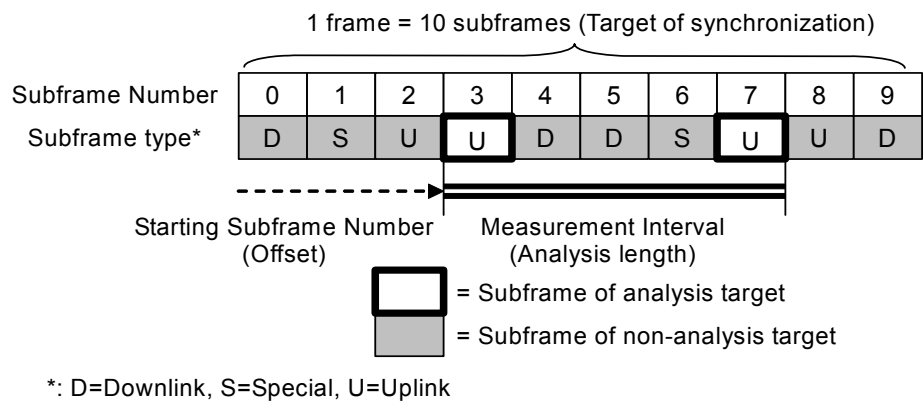

Figure 3.6.1.1-1 Setting example when Measurement Interval resolution = Subframe

(Starting Subframe Number = 3, Measurement Interval = 5)

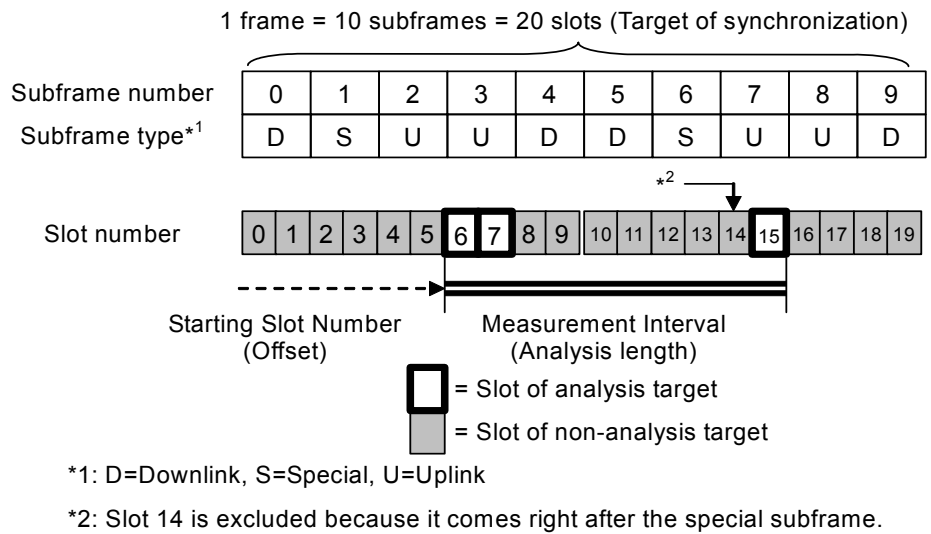

Figure 3.6.1.1-2 Setting example when Measurement Interval resolution = Slot

(Starting Slot Number = 6, Measurement Interval = 10)

Analysis Frame Position

■ Summary

This sets the analysis starting number in frame units. This setting is enabled when Capture Time is set to Manual. If Storage Mode is Off, the setting range is determined assuming Storage Count is 1.

■ Setting range

When Capture Time is Auto: 0

Capture Time = Manual, and

Storage mode is Off. 0 to (Capture Time Length-5)

Other than the above 0 to (Capture Time Length-Storage Count×5)

3.6.1.2 Trace (other than Summary)

Sets the trace. Pressing **F1** (Trace) on page 2 of the Modulation Analysis function menu or **Trace** displays the Trace function menu. The menu screen depends on the selection of Trace Mode.

For the menu screen of Summary, see 3.6.1.3 “Trace (Summary) .”

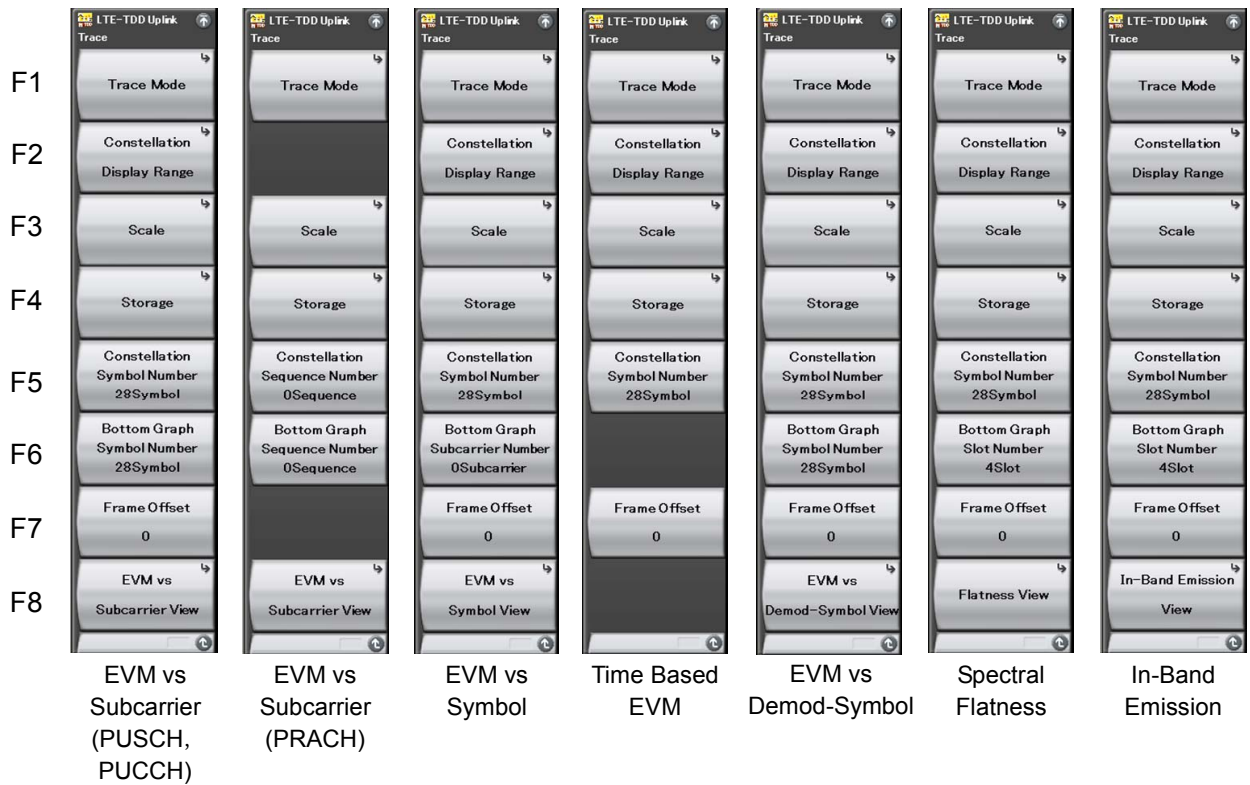

Figure 3.6.1.2-1 Trace Function Menu

Table 3.6.1.2-1 Trace Function Menu

Function Keys	Menu Display	Function
F1	Trace Mode	Sets the result type to be displayed on the graph window.
F2	Constellation Display Range	Sets the range of symbols to be displayed in a constellation.
F3	Scale	Sets vertical scale of a graphical result.
F4	Storage	Sets the storage mode.
F5	Constellation Symbol Number	This command sets the symbol number of the constellation displayed.
	Constellation Sequence Number	Sets preamble sequence number of a constellation displayed.
F6	Bottom Graph Symbol Number	This command sets the symbol number of the displayed EVM vs Subcarrier/EVM vs Demod-Symbol.
	Bottom Graph Slot Number	Sets the Spectral Flatness or In-Band Emission display Slot number.
	Bottom Graph Subcarrier Number	This command sets the subcarrier number of the displayed EVM vs Symbol.
	Bottom Graph Sequence Number	Sets preamble sequence number of EVM vs Symbol displayed.
F7	Frame Offset	Sets the Frame Number which indicates the range of measurement result to be displayed on the graph.
F8	EVM vs Subcarrier View	Sets whether to enable averaging in EVM vs Subcarrier, and the display type.
	EVM vs Symbol View	Sets whether to enable averaging in EVM vs Symbol, and the display type.
	EVM vs Demod-Symbol View	Sets whether to enable averaging in EVM vs Demod-Symbol, and the display type.
	Flatness View	Sets whether to enable averaging for Spectral Flatness, and the display type.
	In-Band Emission View	Sets whether to enable averaging for In-Band Emission, and the display type.

Trace Mode

■ Summary

Sets the result type to be displayed on the graph window.

■ Options

EVM vs Subcarrier

Displays EVM vs Subcarrier in the graph window.

EVM vs Symbol

Displays EVM vs Symbol in the graph window.

Spectral Flatness

Displays Spectral Flatness in the graph window.

Time Based EVM

Displays Time Based EVM in the graph window.

EVM vs Demod-Symbol

Displays EVM vs Demod-Symbol in the graph window.

In-Band Emission

Displays In-Band Emission in the graph window.

Summary

Displays the EVM data for each channel in the graph window, and the power of each slot.

Note:

Constellation is not displayed when Trace Mode is set to Summary.

Table 3.6.1.2-2 The Availability Of Graph Display According To Target Channel

Trace Mode	PUSCH	PUCCH	PRACH
EVM vs Subcarrier	Yes	Yes	Yes
EVM vs Symbol	Yes	Yes	
Spectral Flatness	Yes	Yes	
Time Based EVM	Yes		
EVM vs Demod-Symbol	Yes		
In-Band Emission	Yes	Yes	
Summary	Yes	Yes	Yes

Constellation Display Range

■ Summary

Sets the range of symbols to be displayed in a constellation.

Note:

This is displayed except the case of EVM vs Subcarrier (PRACH).

■ Options

Symbol	Displays a constellation of the SC-FDMA symbol specified in Constellation Symbol Number.
Composite	Displays a constellation of all SC-FDMA symbols in the analysis range set in Analysis Time.

Scale

■ Summary

Sets vertical scale of a graphical result.

■ Options

EVM Unit	Sets the unit of EVM (%/dB).
EVM Scale	Sets the upper limit for the EVM scale.
Flatness Scale	Sets a scale of Spectral Flatness.

Scale: EVM Scale

■ Summary

Sets the upper limit for the EVM scale.

■ Setting range

When EVM Unit is set to %: 1 to 100 %

When EVM Unit is set to dB: -60 to 0 dB

Scale: Flatness Scale

■ Summary

Sets a scale of Spectral Flatness.

■ Setting range

Amplitude	Sets the upper and lower limit values of Amplitude in Spectral Flatness. Setting range	1.0 to 100.0 dB
Difference Amplitude	Sets the upper and lower limit values of Difference Amplitude in Spectral Flatness. Setting range	0.1 to 10.0 dB
Phase	Sets the upper and lower limit values of Phase in Spectral Flatness. Setting range	1.0 to 180.0 degree
Group Delay	Sets the upper and lower limit values of Group Delay in Spectral Flatness. Setting range	1.0 to 1000.0 ns

Storage

■ Summary

Sets the storage mode.

■ Options

Mode	Sets the storage mode.
Count	Sets the number of measurements.

Storage: Mode

■ Summary

Sets the storage mode.

■ Options

Off	Updates data for every sweeping.
On	Averages and displays the average value, maximum value, and minimum value (of only specified result values).

Storage: Count

■ Summary

Sets the number of measurements.

■ Setting range

2 to 9999 When Capture Time is Auto.

2 to Capture Time Length/5
When Capture Time is Manual and Target
Channel is not PRACH.

2 to Capture Time Length/2
When Capture Time is Manual and Target
Channel is PRACH.

Constellation Symbol Number

■ Summary

This command sets the symbol number of the constellation
displayed.

Note:

These settings are enabled only for Constellation.

This is displayed except the case of EVM vs Subcarrier (PRACH).

■ Setting range

0 to 139

 3.6.1.1 “Analysis Time”

Constellation Sequence Number

■ Summary

Sets the Preamble Sequence number of a Constellation displayed.

Note:

These settings are enabled only for Constellation.

This is displayed in the case of EVM vs Subcarrier (PRACH).

■ Setting range

When Preamble Format is 0, 1, or 4: 0

When Preamble Format is 2 or 3: 0 to 1

Bottom Graph Symbol Number**■ Summary**

Sets the Symbol number to display the result of EVM vs Subcarrier (PUSCH,PUCCH) or EVM vs Demod-Symbol.

Note:

This parameter can be set when EVM vs Subcarrier View or EVM vs Demod-Symbol View is Each Symbol.

■ Setting range

0 to 139

 3.6.1.1 "Analysis Time"

3

Measurement

Bottom Graph Sequence Number**■ Summary**

Specifies the Preamble Sequence number to display the result of EVM vs Subcarrier (PRACH).

Note:

This parameter can be set when EVM vs Symbol View is Each Preamble Sequence.

■ Setting range

When Preamble Format is 0, 1, or 4:	0
When Preamble Format is 2 or 3:	0 to 1

Bottom Graph Slot Number**■ Summary**

Sets the Spectral Flatness or In-Band Emission display Slot number.

Note:

This parameter can be set when Flatness View or In-Band EmissionView is Each Slot.

■ Setting range

0 to 19

 3.6.1.1 "Analysis Time"

Bottom Graph Subcarrier Number

■ Summary

Sets the subcarrier number of the displayed EVM vs Symbol.

Note:

This parameter can be set when EVM vs Symbol View is Each Subcarrier.

■ Setting range

0 to 1199	Channel Bandwidth: 20 MHz
0 to 899	Channel Bandwidth: 15 MHz
0 to 599	Channel Bandwidth: 10 MHz
0 to 299	Channel Bandwidth: 5 MHz
0 to 179	Channel Bandwidth: 3 MHz
0 to 71	Channel Bandwidth: 1.4 MHz

 3.5 “Setting Common Items”

Frame Offset

■ Summary

Sets the Frame Number which indicates the range of measurement result to be displayed on the graph.

Note:

This is displayed except the case of EVM vs Subcarrier (PRACH).

■ Setting range

0 to 4

EVM vs Subcarrier View

■ Summary

Sets the display type for EVM vs Subcarrier.

■ Options

When Target Channel is PUSCH or PUCCH:

Each Symbol Displays EVM vs Subcarrier of Symbol set in Bottom Graph Symbol Number.

Averaged over all Symbols

Displays the average EVM vs Subcarrier in symbol units of the analysis length set in Measurement Interval.

Note:

This is fixed to Each Symbol when Target Channel is PUCCH.

When Target Channel is PRACH:

Each Preamble Sequence

Displays EVM vs Subcarrier of the Preamble Sequence position set in Bottom Graph Preamble Sequence Number.

Averaged over all Preamble Sequences

Displays the average EVM vs Subcarrier of all the Preamble Sequence.

Note:

This is fixed to Each Preamble Sequence when Preamble Format is 0, 1, or 4.

EVM vs Symbol View

■ Summary

Sets the display type for the EVM vs Symbol.

■ Options

Each Subcarrier

Displays EVM vs Symbol of the subcarrier set by Bottom Graph Subcarrier Number.

Averaged over all Subcarriers

Displays the average EVM vs Symbol in all subcarriers.

Flatness View

■ Summary

This sets the Spectral Flatness display type.

■ Options

Each Slot Displays the Spectral Flatness of the Slot number specified for Bottom Graph Slot Number.

Averaged over all Slots
 Displays the average Spectral Flatness data in slot units of the analysis length set in Measurement Interval.

Note:

This is fixed to Each Slot when Target Channel is PUCCH.

Flatness View: Flatness Type

■ Summary

This command sets the Spectral Flatness display type.

■ Options

Amplitude Displays Amplitude of Spectral Flatness.

Difference Amplitude
 Sets the Difference Amplitude in Spectral Flatness.

Phase Displays Phase of Spectral Flatness.

Group Delay Displays Group Delay of Spectral Flatness.

EVM vs Demod-Symbol View

■ Summary

Sets the display type for the EVM vs Demod-Symbol.

■ Options

Each Symbol Displays the EVM vs Demod-Symbol of the Symbol number specified for Bottom Graph Symbol Number.

Averaged over all Symbols
 Displays the average EVM vs Demod-Symbol in symbol units of the analysis length set in Measurement Interval.

In-Band Emission View**■ Summary**

This command sets the In-Band Emission graph display type.

■ Options

Each Slot Displays the In-Band Emission of the Slot number specified for Bottom GraphSlot Number.

Averaged over all Slots Displays the average In-Band Emission in slot units of the analysis length set in Measurement Interval.

Note:

This is fixed to Each Slot when Target Channel is PUCCH.

In-Band Emission View: In-Band Emission Type**■ Summary**

This command sets the In-Band Emission graph display type.

■ Options

General & IQ Image Displays a measurement graph based on the 1RB Power value.

Carrier leakage Displays the In-Band Emission graph for the total power of all Allocated RBs.

3.6.1.3 Trace (Summary)

Sets the trace. Pressing **F1** (Trace) on page 2 of the Modulation Analysis function menu or **Trace** displays the Trace function menu. The function menu when Trace Mode is set to Summary is shown below.

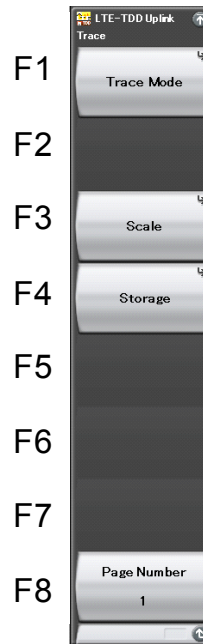

Figure 3.6.1.3-1 Trace (Summary) function menu

Table 3.6.1.3-1 Trace Function Menu

Function Keys	Menu Display	Function
F1	Trace Mode	Sets the result type to be displayed on the graph window.
F3	Scale	Sets the unit of EVM.
F4	Storage	Sets the storage mode.
F8	Page Number	Sets the page number to be displayed.

Trace Mode

■ Summary

Sets the result type to be displayed on the graph window.

Note:

The Trace function menu differs according to this function setting.

■ Options

EVM vs Subcarrier

Displays EVM vs Subcarrier in the graph window.

EVM vs Symbol

Displays EVM vs Symbol in the graph window.

Time Based EVM

Displays Time Based EVM in the graph window.

EVM vs Demod-Symbol

Displays EVM vs Demod-Symbol in the graph window.

Spectral Flatness

Displays Spectral Flatness in the graph window.

In-Band Emission

Displays In-Band Emission in the graph window.

Summary

Displays the EVM data for each channel in the graph window, and the power of each slot.

Note:

Constellation is not displayed when Trace Mode is set to Summary.

Scale

■ Summary

Sets the unit of the measured result.

■ Options

EVM Unit Sets the unit of EVM (%/dB).

Storage

■ Summary

Sets the storage mode.

■ Options

Mode Sets the storage mode.

Count Sets the number of measurements.

Storage: Mode

■ Summary

Sets the storage mode.

■ Options

- | | |
|-----|--|
| Off | Updates data for every sweeping. |
| On | Averages and displays the average value, maximum value, and minimum value (of only specified result values). |

Storage: Count

■ Summary

Sets the number of measurements.

■ Setting range

- | | |
|----------------------------|--|
| 2 to 9999 | When Capture Time is Auto. |
| 2 to Capture Time Length/5 | When Capture Time is Manual and Target Channel PRACH is Exclude. |
| 2 to Capture Time Length/2 | When Capture Time is Manual and Target Channel PRACH is Include. |

Page Number

■ Summary

Sets the page number.

■ Setting range

- | | |
|---------|-----------------------------|
| 1 to 16 | When TargetChannel is PUSCH |
| 1 to 13 | When TargetChannel is PUCCH |
| 1 to 1 | When TargetChannel is PRACH |

3.6.2 Power vs Time

Sets Power vs Time. Pressing **F2** (Power vs Time) on the Measure function menu displays the Power vs Time function menu.

The Power vs Time function menu consists of 2 pages. Press **F7** to display the second page.

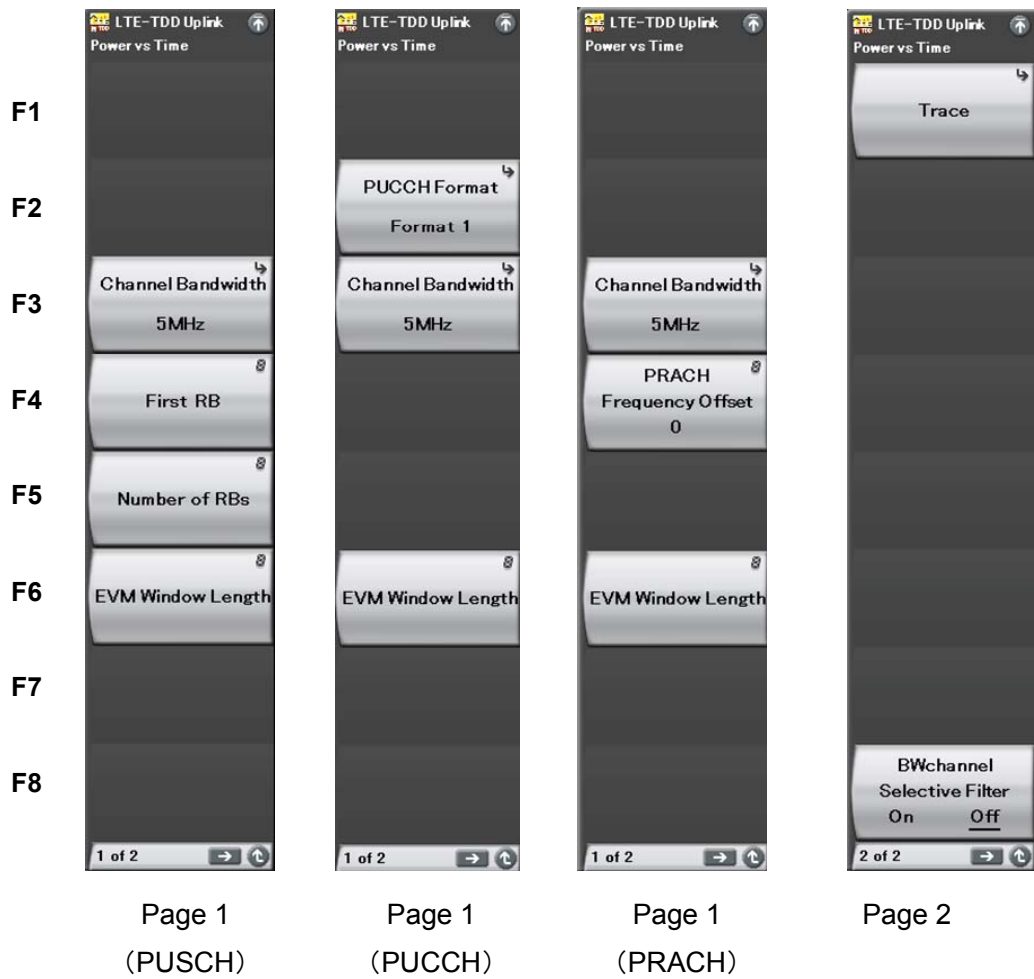



Figure 3.6.2-1 Power vs Time function menu

Table 3.6.2-1 Power vs Time function menu

Function Keys	Menu Display	Function
Page 1		
F2	PUCCH Format	Displays when Target Channel is PUCCH. Sets PUCCH Format.
F3	Channel Bandwidth	Sets Channel Bandwidth.  3.5 “Setting Common Items”
F4	First RB	Displays when Target Channel is PUSCH. Sets first RB number of transmitted RBs.
	PRACH Frequency Offset	Displays when Target Channel is PUSCH. Sets the frequency position of the PRACH signal.
F5	Number of RBs	Sets number of transmitted RBs.
F6	EVM Window Length	Sets the FFT window length.
Page 2		
F1	Trace	Sets the trace.  3.6.1.2 “Trace (other than Summary)”
F8	BWchannel Selective Filter	Set this function to isolate signals out of the transmission band.

PUCCH Format

■ Summary

Sets PUCCH Format.

■ Options

- 1 Sets PUCCH Format to 1
- 1a Sets PUCCH Format to 1a
- 1b Sets PUCCH Format to 1b
- 2 Sets PUCCH Format to 2
- 2a Sets PUCCH Format to 2a
- 2b Sets PUCCH Format to 2b
- 3 Sets PUCCH Format to 3

Note:

The menu is displayed and the settings can be specified only when Target Channel is set to PUCCH.

Format 3 is unavailable when Standard is LTE.

First RB

■ Summary

When Target Channel is PUSCH, assigns the first number of RB to transmit to Subframe0 to 9 individually.

■ Setting range

When the Target Channel is PUSCH.

0 to 99	Channel Bandwidth: 20 MHz
0 to 74	Channel Bandwidth: 15 MHz
0 to 49	Channel Bandwidth: 10 MHz
0 to 24	Channel Bandwidth: 5 MHz
0 to 14	Channel Bandwidth: 3 MHz
0 to 5	Channel Bandwidth: 1.4 MHz

 3.5 “Setting Common Items”

Note:

The menu is displayed and the settings can be specified only when Target Channel is set to PUSCH.

PRACH Frequency Offset

■ Summary

Sets the frequency position of the PRACH signal. The unit is RB.

■ Setting range

0 to 94	Channel Bandwidth: 20 MHz
0 to 69	Channel Bandwidth: 15 MHz
0 to 44	Channel Bandwidth: 10 MHz
0 to 19	Channel Bandwidth: 5 MHz
0 to 9	Channel Bandwidth: 3 MHz
0	Channel Bandwidth: 1.4 MHz

 3.5 “Setting Common Items”

Note:

The menu is displayed and the settings can be specified only when Target Channel is set to PRACH.

Number Of RBs

■ Summary

Sets number of transmitted RBs.

■ Setting range

1 to (100–First RB Number)	Channel Bandwidth: 20 MHz
1 to (75–First RB Number)	Channel Bandwidth: 15 MHz
1 to (50–First RB Number)	Channel Bandwidth: 10 MHz
1 to (25–First RB Number)	Channel Bandwidth: 5 MHz
1 to (15–First RB Number)	Channel Bandwidth: 3 MHz
1 to (6–First RB Number)	Channel Bandwidth: 1.4 MHz

 3.5 “Setting Common Items”

Note:

The settings can be specified only when Target Channel is set to PUSCH.

EVM Window Length (When Target Channel is other than PRACH)

■ Summary

This command sets the FFT window length. There are two setting methods: Ts and W.

If the channel bandwidth is changed, the setting is restored to the default value according to the changed channel bandwidth. (See Table 3.6.2-2.)

■ Setting range

Ts:	0 to 142	
W:	0 to 8	Channel Bandwidth: 1.4 MHz
	0 to 17	Channel Bandwidth: 3 MHz
	0 to 35	Channel Bandwidth: 5 MHz
	0 to 71	Channel Bandwidth: 10 MHz
	0 to 106	Channel Bandwidth: 15 MHz
	0 to 142	Channel Bandwidth: 20 MHz

 3.5 “Setting Common Items”

Table 3.6.2-2 Default value of Channel Bandwidth and EVM Window Length

Channel Bandwidth	EVM Window Length (W)	Conversion from W to Ts
1.4 MHz	5	×16
3 MHz	12	×8
5 MHz	32	×4
10 MHz	66	×2
15 MHz	102	×(2048 / 1536)
20 MHz	136	×1

EVM Window Length

■ Summary

This sets the FET window length. The Ts and W setting methods are available, but the both result in the same value. Note that the setting range varies according to the PRACH Configuration Index value described in 3.5 “Setting Common Items”.

■ Setting range

Ts(W): 0 to 3166	PRACH Configuration Index is 0 to 19
0 to 21022	PRACH Configuration Index is 20 to 29
0 to 6238	PRACH Configuration Index is 30 to 39
0 to 21022	PRACH Configuration Index is 40 to 47
0 to 446	PRACH Configuration Index is 48 to 57

3.6.2.1 Trace



Sets the trace. Pressing  (Trace) on page 2 of the Power vs Time function menu or  displays the Trace function menu.

Table 3.6.2.1-1 Trace Function Menu

Function Keys	Menu Display	Function
F1	Trace Mode	Sets the result type to be displayed on the graph window.
F3	Scale	Sets vertical scale of a graphical result.
F4	Storage	Sets the storage mode.

Trace Mode

■ Summary

Sets the result type to be displayed on the graph window.

■ Options

- Burst Displays Burst graph in the graph window.
- Transient Displays Transient graph in the graph window.
- No Graph Does not display the graph in the graph window.

Scale

■ Summary

Sets vertical scale of a graphical result.

■ Options

- Reference Level Upper
Sets the upper limit of the vertical scale in the graph.
- Reference Level Lower
Sets the lower limit of the vertical scale in the graph.

Scale: Reference Level Upper

■ Summary

Sets the upper limit of the vertical scale in the graph.

■ Setting range

-100+Level Offset to 50+Level Offset

Note:

This can be set as long as Reference Level Upper is bigger than Reference Level Lower.

Scale : Reference Level Lower**■ Summary**

Sets the lower limit of the vertical scale in the graph.

■ Setting range

-100+Level Offset to 50+Level Offset

Note:

This can be set as long as Reference Level Upper is bigger than Reference Level Lower.

Storage**■ Summary**

Sets the storage mode.

■ Options

Mode	Sets the storage mode.
Count	Sets the number of measurements.

Storage : Mode**■ Summary**

Sets the storage mode.

■ Options

Off	Updates data for every sweeping.
On	Averages and displays the average value, maximum value, and minimum value (of only specified result values).

Storage : Count**■ Summary**

Sets the number of measurements.

■ Setting range

2 to 9999	When Capture Time is Auto.
2 to Capture Time Length	When Capture Time is Manual and Target Channel is not PRACH.
2 to Capture Time Length/2	When Capture Time is Manual and Target Channel is PRACH.

3.6.3 Adjacent Channel Power Measurement (ACP)

This calls the ACP function of the Signal Analyzer or Spectrum Analyzer functions. Settings of Carrier Frequency, Input level, Offset, Offset Value and Pre-Amp are automatically reflected on the corresponding parameters. Recall Current Application described in Section 3.6.2 “Recalling parameters” of the “MS2690A/MS2691A/MS2692A Signal Analyzer Operation Manual (Signal Analyzer Function Operation)” or “MS2830A Signal Analyzer Operation Manual (Signal Analyzer Function Operation)” cannot be executed when this function is being recalled.

ACP (FFT)

■ Summary

The ACP function of the Signal Analyzer function is called, and the adjacent channel leakage power is measured according to the handed over parameter settings. This function is only enabled when Channel Bandwidth is set to 1.4, 3, and 5 MHz.

ACP (Swept)

■ Summary

The ACP function of the Spectrum Analyzer function is called, and the adjacent channel leakage power is measured according to the handed over parameter settings.

Note:

This cannot be set when the Replay function is executed.

3.6.4 Channel Power Measurement (Channel Power)

This calls the Channel Power function of the Signal Analyzer or Spectrum Analyzer functions. Settings of Carrier Frequency, Input level, Offset, Offset Value and Pre-Amp are automatically reflected on the corresponding parameters. Recall Current Application described in Section 3.6.2 “Recalling parameters” of the “MS2690A/MS2691A/MS2692A Signal Analyzer Operation Manual (Signal Analyzer Function Operation)” or “MS2830A Signal Analyzer Operation Manual (Signal Analyzer Function Operation)” cannot be executed when this function is being recalled.

Channel Power (FFT)

■ Summary

While these functions are being fetched, the Recall Current Application described in Section 3.6.2 “Recalling parameters” of the MS2690A/MS2691A/MS2692A Signal Analyzer Operation Manual (Mainframe Operation) cannot be executed.

Channel Power (Swept)

■ Summary

Recalls the Channel Power function of the Spectrum Analyzer function and measures the channel power for the reflected parameter settings.

Note:

This cannot be set when the Replay function is executed.

3.6.5 Occupied Bandwidth Measurement (OBW)

This calls the OBW function of the Signal Analyzer or Spectrum Analyzer functions. Settings of Carrier Frequency, Input level, Offset, Offset Value and Pre-Amp are automatically reflected on the corresponding parameters. Recall Current Application described in Section 3.6.2 “Recalling parameters” of the “MS2690A/MS2691A/MS2692A Signal Analyzer Operation Manual (Signal Analyzer Function Operation)” or “MS2830A Signal Analyzer Operation Manual (Signal Analyzer Function Operation)” cannot be executed when this function is being recalled.

OBW (FFT)

■ Summary

The OBW function of the Signal Analyzer function is called, and the occupied bandwidth is measured according to the handed over parameter settings.

OBW (Swept)

■ Summary

The OBW function of the Spectrum Analyzer function is called, and the occupied bandwidth is measured according to the handed over parameter settings.

Note:

This cannot be set when the Replay function is executed.

3.6.6 Spectrum Emission Mask Measurement (SEM)

Recalls the Spectrum Emission Mask function of the Spectrum Analyzer function. Settings of Carrier Frequency, Input level, Offset, Offset Value and Pre-Amp are automatically reflected on the corresponding parameters. Recall Current Application described in Section 3.6.2 “Recalling parameters” of the “MS2690A/MS2691A/MS2692A Signal Analyzer Operation Manual (Signal Analyzer Function Operation)” or “MS2830A Signal Analyzer Operation Manual (Signal Analyzer Function Operation)” cannot be executed when this function is being recalled.

Spectrum Emission Mask (Swept)



■ Summary

Recalls the Spectrum Emission Mask function of the Spectrum Analyzer function and measures the spectrum emission mask for the reflected parameter settings.

Note:

This cannot be set when the Replay function is executed.

3.7 Setting Marker

Perform the marker-related settings. Pressing  (Marker) on the main function menu or  displays the page 1 of the Marker function menu. Also, pressing  displays page 2 of the Marker function menu.

The Marker function menu consists of 2 pages that are toggled by pressing .

Note:

You cannot configure marker settings when Trace Mode is set to Summary.

Table 3.7-1 Marker Function Menu

Function Keys	Menu Display	Function
Page 1		
F1	Graph Marker	Sets the Marker On/Off.
F2	Constellation Select	Sets the target of operation for the rotary knob and the cursor key to Constellation. Not displayed during Power vs Time measurement.
F3	Bottom Graph Select	Sets the target of operation for the rotary knob and the cursor key to the graph window. Not displayed during Power vs Time measurement.
F5	Constellation Marker Number	Sets the target of a marker (Subcarrier or Demod-Symbol) while constellation results are displayed. Not displayed during Power vs Time measurement.
F6	Bottom Graph Marker Number	Sets the target of the marker on the Bottom Graph result display. Not displayed during Power vs Time measurement.
	Graph Marker Number	Sets the target of a marker while Power vs Time results are displayed. Displayed only during Power vs Time measurement.
F7	Frame Offset	Sets the Frame Number which indicates the range of measurement result to be displayed on the graph. Not displayed during Power vs Time measurement.

Table 3.7-1 Marker Function Menu (Cont'd)

Function Keys	Menu Display	Function
Page 2		
F1	Peak Search	Moves the marker to the maximum level point within the measurement range.
F2	Next Peak	Moves the marker to the next largest level point after the current marker level within the measurement range.
F3	Dip Search	Moves the marker to the minimum level position within the measurement range.
F4	Next Dip	Moves the marker to the next smallest level point after the current marker level within the measurement range.

Graph Marker

■ Summary

Sets the Marker On/Off.

■ Options

- On Enables the marker function.
- Off Disables the marker function.

Constellation Select

■ Summary

Sets the target of operation for the rotary knob and the cursor key to Constellation.

Note:

Not displayed during Power vs Time measurement.

Bottom Graph Select

■ Summary

Sets the target of operation for the rotary knob and the cursor key to the graph window.

Note:

Not displayed during Power vs Time measurement.

Constellation Marker Number

■ Summary

Sets the target of a marker (Subcarrier or Demod-Symbol) while constellation results are displayed.

■ Setting range

When Target Channel is not set to PRACH, and TraceMode is set to EVM vs Subcarrier, EVM vs Symbol, Spectral Flatness, In-BandEmission or EVM vs Demod Symbol, Time Based EVM:

0 to 1199	Channel Bandwidth: 20 MHz
0 to 899	Channel Bandwidth: 15 MHz
0 to 599	Channel Bandwidth: 10 MHz
0 to 299	Channel Bandwidth: 5 MHz
0 to 179	Channel Bandwidth: 3 MHz
0 to 71	Channel Bandwidth: 1.4 MHz



3.5 “Setting Common Items”

When Target Channel is set to PRACH and Preamble Format is set to 0 to 3:

0 to 838

When Target Channel is set to PRACH and Preamble Format is set to 4:

0 to 138

Note:

Not displayed during Power vs Time measurement.

Bottom Graph Marker Number

■ Summary

Sets the target of the marker on the Bottom Graph result display.

■ Setting range

When Target Channel is not set to PRACH, and TraceMode is set to EVM vs Subcarrier, EVM vs Demod-Symbol, or Spectral Flatness (Amplitude, Phase) :

0 to 1199	Channel Bandwidth: 20 MHz
0 to 899	Channel Bandwidth: 15 MHz
0 to 599	Channel Bandwidth: 10 MHz
0 to 299	Channel Bandwidth: 5 MHz
0 to 179	Channel Bandwidth: 3 MHz
0 to 71	Channel Bandwidth: 1.4 MHz

 3.5 “Setting Common Items”

When Target Channel is not set to PRACH, and TraceMode is set to Spectral Flatness (Difference Amplitude, Group Delay):

1 to 1198	Channel Bandwidth: 20 MHz
1 to 898	Channel Bandwidth: 15 MHz
1 to 598	Channel Bandwidth: 10 MHz
1 to 298	Channel Bandwidth: 5 MHz
1 to 178	Channel Bandwidth: 3 MHz
1 to 70	Channel Bandwidth: 1.4 MHz

When Target Channel is not set to PRACH, and TraceMode is set to In-Band Emission :

0 to 99	Channel Bandwidth: 20 MHz
0 to 74	Channel Bandwidth: 15 MHz
0 to 49	Channel Bandwidth: 10 MHz
0 to 24	Channel Bandwidth: 5 MHz
0 to 14	Channel Bandwidth: 3 MHz
0 to 5	Channel Bandwidth: 1.4 MHz

When Target Channel is not set to PRACH, and TraceMode is set to EVM vs Symbol or Time Based EVM:

0 to 139

 3.6.1.1 “Analysis Time”

 3.6.1 “Modulation Analysis”

When Target Channel is PRACH:

0 to 2047

Note:

Not displayed during Power vs Time measurement.

Graph Marker Number

■ Summary

Sets the target of a marker during Power vs Time measurement.

■ Setting range

When Target Channel is PUSCH, PUCCH:

39504 to 122879 Trace Mode: Burst

59904 to 93695 Trace Mode: Transient

When Target Channel is PRACH:

-18166 to 58463 Trace Mode: Burst (Preamble Format0)

-18166 to 76319 Trace Mode: Burst (Preamble Format1)

-18166 to 86111 Trace Mode: Burst (Preamble Format2)

-18166 to 100895 Trace Mode: Burst (Preamble Format3)

-18166 to 35263 Trace Mode: Burst (Preamble Format4)

-1536 to 29279 Trace Mode: Transient (Preamble Format0)

-1536 to 47135 Trace Mode: Transient (Preamble Format1)

-1536 to 56927 Trace Mode: Transient (Preamble Format2)

-1536 to 71711 Trace Mode: Transient (Preamble Format3)

-1536 to 6079 Trace Mode: Transient (Preamble Format4)

Note:

Displayed only during Power vs Time measurement.

Frame Offset

■ Summary

Sets the Frame Number which indicates the range of measurement result to be displayed on the graph.

■ Setting range

0 to 4

Note:

Not displayed during Power vs Time measurement.

Peak Search

■ Summary

When Trace Mode is not set to Spectral Flatness or In-Band Emission:

Moves the marker to the maximum level point within the measurement range. Moves the marker to the point corresponding to the smallest value (left side of the scale) on the horizontal axis (Subcarrier, or Symbol), when there are multiple maximum level points.

When Spectral Flatness or In-Band Emission is selected for Trace Mode:

Moves the marker to the maximum level point for the Average waveform data.

Next Peak

■ Summary

When Trace Mode is not set to Spectral Flatness or In-Band Emission:

Moves the marker to the next largest level point after the current marker level within the measurement range. Moves the marker to the point corresponding to the smallest value (left side of the scale) on the horizontal scale, when there are multiple points. However, if the point is the same value as the marker level, the marker is moved to the next maximum point to the horizontal axis position of the marker.

Note that a search error occurs if Marker selection is executed when displaying a minimum value graph.

When Spectral Flatness or In-Band Emission is selected for Trace Mode:

Moves the marker to the next largest level point for the Average waveform data.

Dip Search

■ Summary

Moves the marker to the minimum level position within the measurement range. Move the marker to the largest point (right side of the scale) on the horizontal axis, if there are multiple minimum level points. (The measurement graph operation is the same as for Peak Search.)



Next Dip

■ Summary

Moves the marker to the next smallest level point after the current marker level within the measurement range. When there are multiple points, the point corresponding to the greatest value (right side of the scale) on the horizontal axis is selected. However, if the point is the same value as the marker level, the marker is moved to the next minimum point to the horizontal axis position of the marker. (The measurement graph operation is the same as for Next Search.)

Note that a search error occurs if Marker selection is executed when displaying a maximum value graph.

3.8 Setting Trigger

Configures settings of a trigger. Pressing  (Trigger) on the main function menu or  displays the Trigger function menu.

Note:

The trigger setting is unavailable when the Replay function is executed.

Table 3.8-1 Trigger Function Menu

Function Keys	Menu Display	Function
F1	Trigger Switch	Sets the trigger synchronization On/Off.
F2	Trigger Source	Sets the trigger source.
F3	Trigger Slope	Sets the trigger polarity.
F4	Trigger Level	Sets the trigger Level for the Video trigger.
F8	Trigger Delay	Sets the trigger delay.

Trigger Switch

■ Summary

This sets the trigger synchronization On/Off.

■ Options

- On Enables the trigger function.
- Off Disables the trigger function.

Note

If Target Channel is set to PRACH, this parameter is automatically fixed to ON.

Trigger Source

■ Summary

This sets the trigger source.

■ Options

- External Measurement starts with external trigger signal input.
- SG Marker Starts measurement by the timing of internal Vector Signal Generator option.
- Video Starts measurement by using a Video trigger.

Note

If Target Channel is set to PRACH, this parameter is automatically switched to Video.

If Target Channel is not set to PRACH and option 020 is installed, External or SG Marker can be specified.

Trigger Slope

■ Summary

Sets the trigger polarity.

■ Options

- Rise Synchronizes with rising edge of the trigger.
- Fall Synchronizes with falling edge of the trigger.

Trigger Delay

■ Summary

Sets the trigger delay.

■ Setting range

- 2 to +2 s Span: 31.25 MHz
- 1 to +1 s Span: 62.5 MHz
- 500 to +500 ms Span: 125 MHz

Trigger Level

■ Summary

Sets the trigger Level for the Video trigger.

■ Setting range

(-150 dBm+Offset Value) to (50+Offset Value) dBm

Note

Depending on the Configuration Index setting, more than one Preamble might be allocated to 1 frame, but the measurement target is the Preamble signal at the location to which the trigger applies.

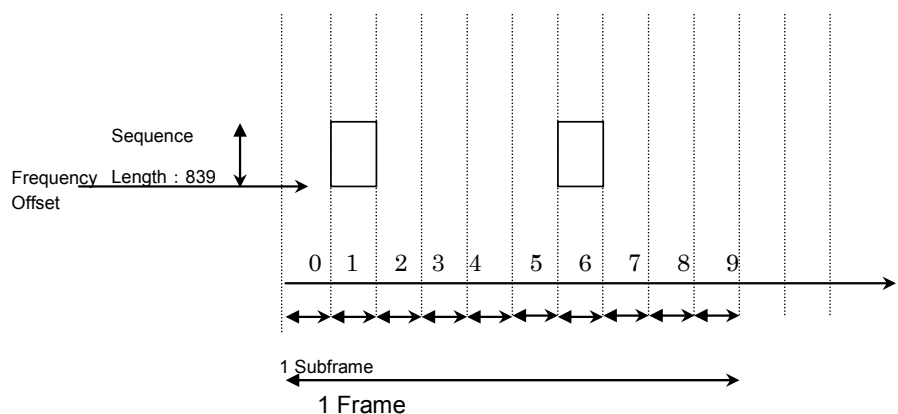

Figure 3.8-1 PRACH Signal 1 Frame Preamble Signal Allocation Position

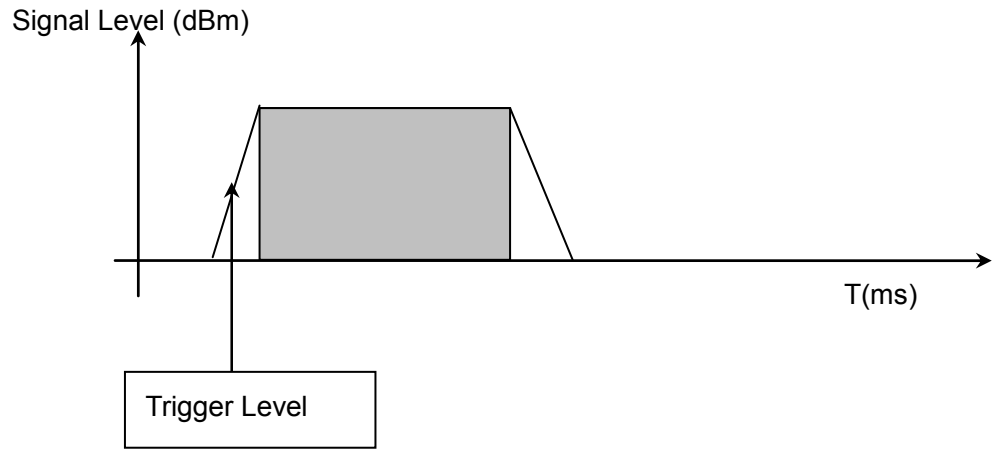

Figure 3.8-2 Video Trigger Example

The measurement target signal is triggered in accordance with the Trigger Level value of the Video trigger. The measurement target is the Preamble signal to which this trigger applies.

Note:

This is available when Target channel is PRACH.

3.9 EVM Display

Displays EVM analysis results. The result of each analysis is displayed if the storage mode is disabled (Off), and the average, maximum, and minimum (only Output Power and Mean Power) of the analysis results are displayed if the mode is enabled (On).

 3.6.1.2 “Trace (other than Summary)”

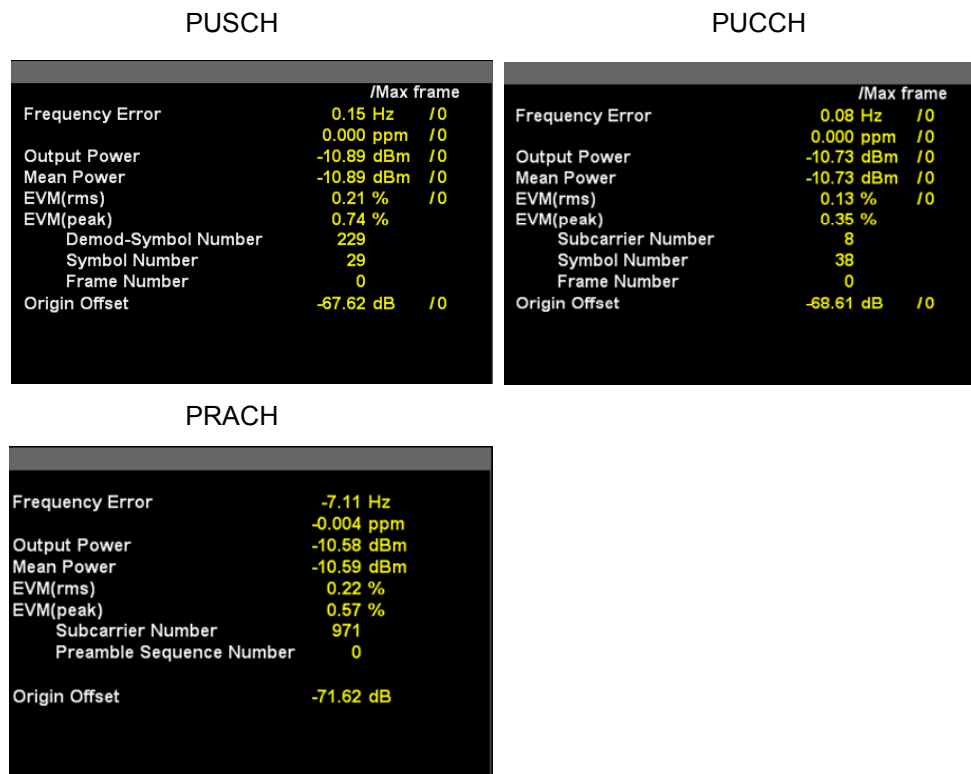

3
Measurement

Figure 3.9-1 Result Window

Frequency Error

■ Summary

Displays the average frequency error in the range set in Starting Subframe/Slot Number and Measurement Interval.

 3.6.1.2 “Trace (other than Summary)”

Output Power

■ Summary

Displays the average power of whole Frequency Span within the range that is determined by the Starting Subframe/Slot Number and Measurement Interval settings.

Mean Power

■ Summary

Displays the average power value in the bandwidth set by Channel Bandwidth within the range determined by Starting Subframe/Slot Number and Measurement Interval.

EVM (rms)

■ Summary

Displays the root square average EVM of all the subcarriers (all Demod-Symbol when Target Channel is PUSCH) calculated by horizontal time axis within the range determined by Starting Subframe/Slot Number and Measurement Interval.

Switches between % and dB according to settings of EVM Unit.

 3.6.1.2 “Trace (other than Summary)”

EVM (peak)

■ Summary

Displays the maximum EVM of all subcarriers (all Demod-Symbol when Target Channel is PUSCH) and all symbols calculated by horizontal time axis in the range determined by Starting Subframe/Slot Number and Measurement Interval.

Switches between % and dB according to settings of EVM Unit.

EVM (peak) Symbol Number

■ Summary

Displays the symbol number of EVM (peak).
It is displayed for PUCCH and PUSCH.

EVM (peak) Demod-Symbol Number

■ Summary

Displays the Demod-Symbol number of EVM (peak).
It is displayed for PUSCH.

EVM (peak) Frame Number

■ Summary

Displays the frame number of EVM (peak).
It is displayed for PUCCH and PUSCH.

EVM (peak) Subcarrier Number

■ Summary

Displays the subcarrier number of EVM (peak).
It is displayed for PRACH and PUCCH.

EVM (peak) Preamble Sequence Number

■ Summary

Displays the preamble sequence number of EVM (peak).
It is displayed for PRACH.

Origin Offset

■ Summary

Displays the average origin offset in the range set in Starting Subframe/Slot Number and Measurement Interval.

Time Offset

■ Summary

Displays the time offset between the trigger input and the head of the frame. This value is displayed only if the trigger function is enabled, or while the Replay function is executed and the storage mode is disabled. This value is displayed if the TriggerSource setting is External or SGMaker.

Max Frame Number

■ Summary

Sets the maximum Frame number.

3.10 Constellation

Displays a constellation of the symbol specified in Constellation Symbol Number.

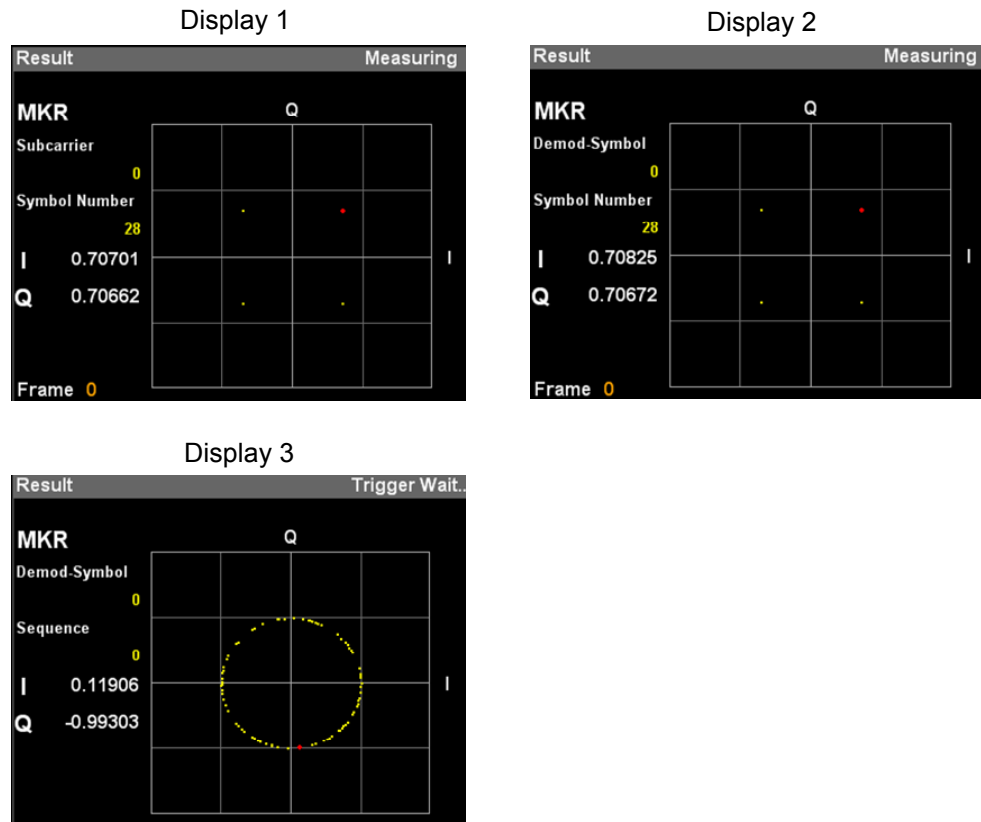

Figure 3.10-1 Constellation

Graph display

■ Summary

When Target Channel is not PRACH, it displays a constellation of all subcarriers (all Demod-Symbol when Target Channel is PUSCH) in the symbol set in Constellation Symbol Number, with it overlapped.

When Target Channel is PRACH, it displays a constellation of all Demod -Symbols in the preamble sequence set in Constellation Sequence Number, with it overlapped. The marker-selected subcarrier is displayed in red.

 3.6.1.2 "Trace (other than Summary)"

Table 3.10-1 Constellation

Display	Settings		Constellation
	Target	Trace Mode	
Display 1	PUSCH PUCCH	EVM vs Subcarrier	Displays I and Q values in all Subcarriers.
		EVM vs Symbol	
		Spectral Flatness	
		In-Band Emission	
Display 2	PUSCH	EVM vs Demod-Symbol	Displays I and Q values of all Demod-Symbol values.
		Time Based EVM	
Display 3	PRACH	EVM vs Subcarrier	Displays I and Q values of all Demod-Symbol values for each Constellation Preamble Sequence Number.

MKR Subcarrier

■ Summary

Displays the marker-selected subcarrier number. The marker can be moved with the cursor key or the rotary knob. This parameter is displayed when Target Channel is set to other than PRACH and Trace Mode is EVM vs Subcarrier, EVM vs Symbol, Spectral Flatness, or In-Band Emission.

MKR Demod-Symbol

■ Summary

Displays the Demod-Symbol number selected by the marker. The marker can be moved with the cursor key or the rotary knob. This parameter is displayed when Target Channel is PRACH and Trace Mode is Time Based EVM or EVM vs Demod-Symbol.

Symbol Number

■ Summary

Displays the symbol number set in Constellation Symbol Number. This is displayed if Target Channel is set to a value other than PRACH.

Sequence Number

■ Summary

Displays the Preamble sequence number set in Constellation Sequence Number. This is displayed if Target Channel is set to PRACH.

MKR I/Q

■ Summary

Displays the amplitude value of I/Q of the marker-selected subcarrier (or Demod-Symbol). The marker can be moved with the cursor key or the rotary knob.

3.11 EVM vs Subcarrier

Displays EVM for each subcarrier.

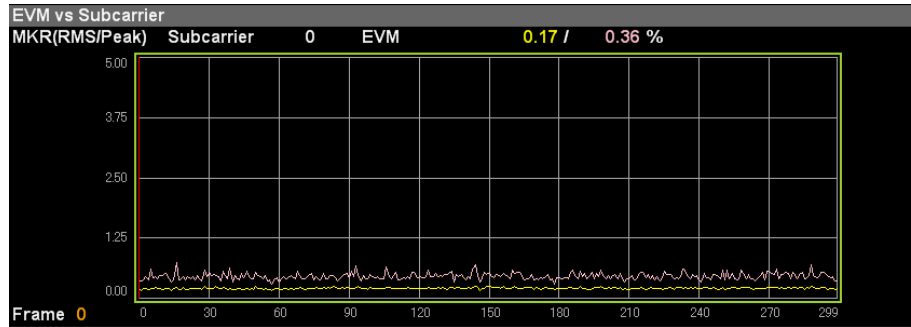

Figure 3.11-1 EVM vs Subcarrier (PUSCH)

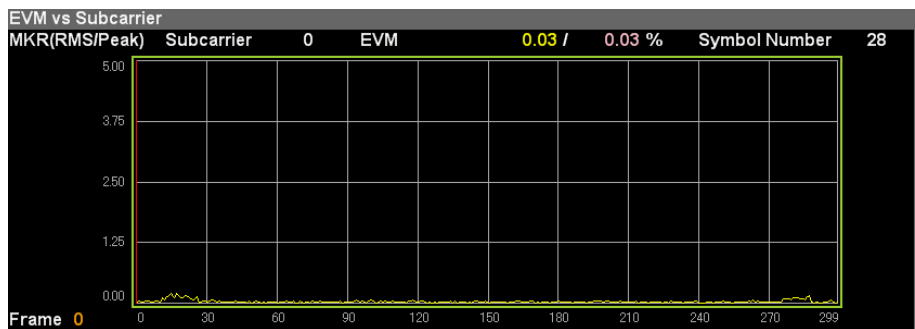

Figure 3.11-2 EVM vs Subcarrier (PUCCH)

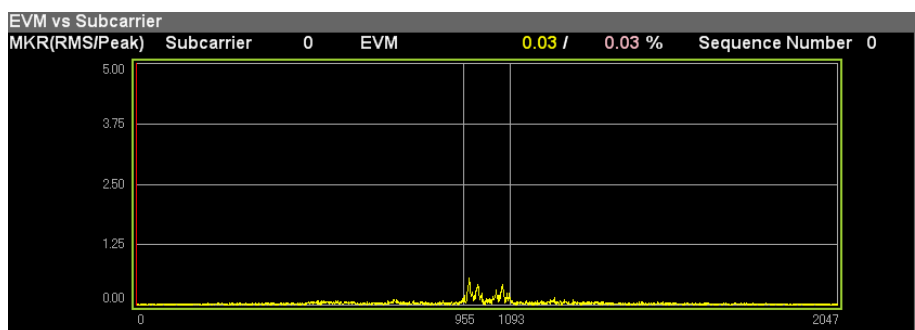



Figure 3.11-3 EVM vs Subcarrier (PRACH)

Graph display

■ Summary

Displays EVM (Y axis) for each subcarrier (X axis). EVM for each subcarrier is based on settings of EVM vs Subcarrier View.

The marker-selected subcarrier is displayed in red.

 3.6.1.2 "Trace (other than Summary)"

MKR Subcarrier

■ Summary

Displays the marker-selected subcarrier number. The marker can be moved with the cursor key or the rotary knob.

MKR EVM

■ Summary

Displays the average and maximum EVM values of the marker-selected subcarriers. The EVM value is submitted to the settings of EVM vs Subcarrier View.

Symbol Number

■ Summary

Displays the Bottom Graph Symbol Number set in EVM vs Subcarrier.

Note:

Displays it only when the settings of EVM vs Subcarrier View are Each Symbol.

Sequence Number

■ Summary

Displays the Bottom Graph Sequence Number set in EVM vs Subcarrier.

Note:

Displays it only when the setting of EVM vs Subcarrier View is Each Preamble Sequence.

3.12 EVM vs Symbol

Displays EVM for each Symbol in PUSCH or PUCCH.



Figure 3.12-1 EVM vs Symbol (PUSCH)

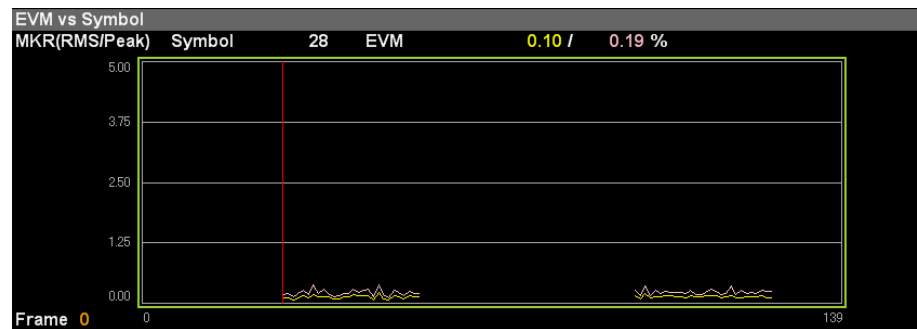



Figure 3.12-2 EVM vs Symbol (PUCCH)

Graph display

■ Summary

Displays EVM (Y axis) for each symbol (X axis). EVM of each symbol is based on settings of EVM vs Symbol View.

The symbol selected by the marker is displayed in red.

 3.6.1.2 “Trace (other than Summary)”

MKR Symbol

■ Summary

Displays the marker-selected symbol number. The marker can be moved with the cursor key or the rotary knob.

MKR EVM

■ Summary

Displays the average and maximum EVMs of the symbol selected by the marker. The EVM value is submitted to the settings of EVM vs Symbol View.

Subcarrier Number

■ Summary

Displays the Bottom Graph Subcarrier Number set in EVM vs Symbol.

Note:

Displays it only when the settings of EVM vs Symbol View are Each Subcarrier.

3.13 Time Based EVM

Displays the EVM for each symbol measured in the time domain. Only PUSCHs are displayed in the Time Based EVM graph. The results are not displayed for symbols that do not have a PUSCH.



Figure 3.13-1 Time Based EVM

Graph display

■ Summary

Displays EVM (Y axis) for each symbol (X axis).

The symbol selected by the marker is displayed in red.

 3.6.1.2 “Trace (other than Summary)”

MKR Symbol

■ Summary

Displays the marker-selected symbol number. The marker can be moved with the cursor key or the rotary knob.

MKR EVM

■ Summary

Displays the average and maximum EVMs of the symbol selected by the marker.

3.14 EVM vs Demod-Symbol

Displays the EVM for each Demod-symbol in PUSCH. The EVM of the symbol without PUSCH is not displayed.

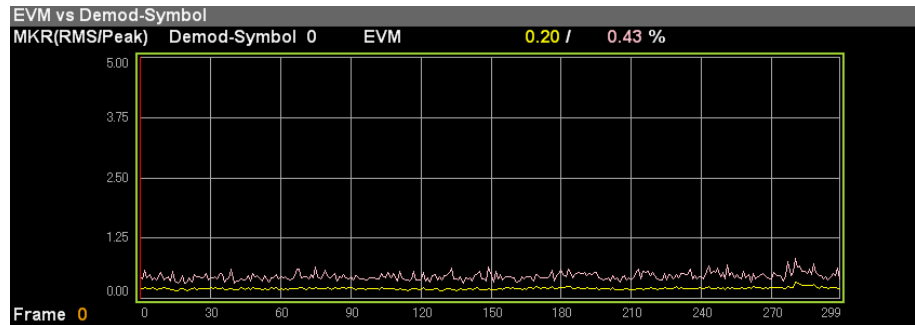



Figure 3.14-1 EVM vs Demo-Symbol

Graph display

■ Summary

Displays EVM (Y axis) for each symbol (X axis). EVM of each symbol is based on settings of EVM vs Demod-Symbol View. The Demod-symbol selected by the marker is displayed in red.

 3.6.1.2 “Trace (other than Summary)”

MKR Demod-Symbol

■ Summary

Displays the marker-selected symbol number. The marker can be moved with the cursor key or the rotary knob.

MKR EVM

■ Summary

Displays the average and maximum EVM of the Demod-Symbol selected by the marker.

Symbol Number

■ Summary

Displays the Bottom Graph Symbol Number set in EVM vs Demod-Symbol.

Note:

This is displayed when EVM vs Demod-Symbol View is Each Symbol.

3.15 Spectral Flatness

Displays the measurement results of Spectral Flatness in PUSCH or PUCCH.

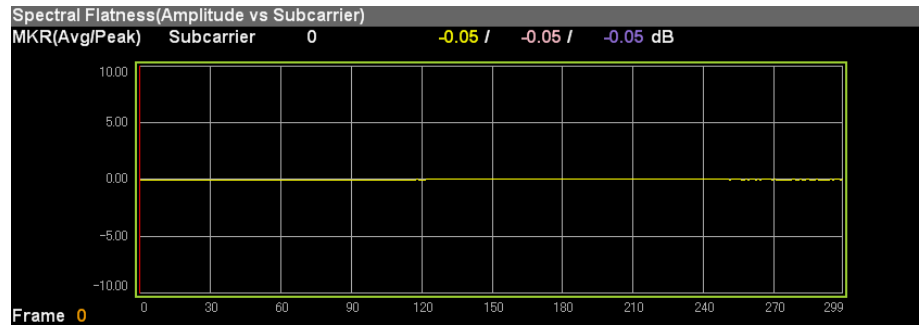

Figure 3.15-1 Amplitude of Spectral Flatness Display (PUSCH)

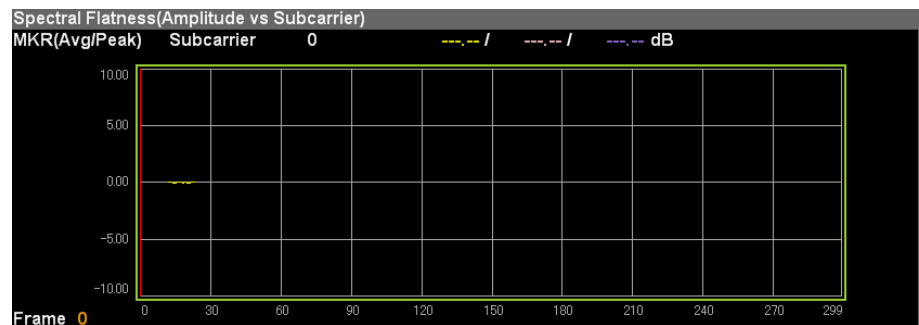



Figure 3.15-2 Amplitude of Spectral Flatness Display (PUCCH)

3
Measurement

Graph display

■ Summary

Displays the Spectral Flatness value of an input signal by displaying averaged Amplitude (Y axis) for each subcarrier (X axis). Note that the Slot setting depends on Flatness View.

 3.6.1.2 “Trace (other than Summary)”

The marker-selected subcarrier is displayed in red.

MKR Subcarrier

■ Summary

Displays the marker-selected subcarrier number. The marker can be moved with the cursor key or the rotary knob.

MKR Amplitude

■ Summary

Displays the spectral flatness average of the subcarriers selected by the marker, as well as the maximum and minimum Amplitude.

MKR Difference Amplitude

■ Summary

Displays the spectral flatness average of the subcarriers selected by the marker, as well as the maximum and minimum Difference Amplitude (the level difference between adjacent subcarriers).

MKR Phase

■ Summary

Displays the spectral flatness average of the subcarriers selected by the marker, as well as the maximum and minimum Phase.

MKR Group Delay

■ Summary

Displays the spectral flatness average of the subcarriers selected by the marker, as well as the maximum and minimum Group Delay.

Slot Number

■ Summary

Displays the Bottom Graph Slot Number set in Spectral Flatness.

Note:

This is displayed when Flatness View is Each Slot.

3.16 In-Band Emission

Displays the measurement results of In-Band Emission in PUSCH or PUCCH.



Figure 3.16-1 In-Band Emission Display (PUSCH)

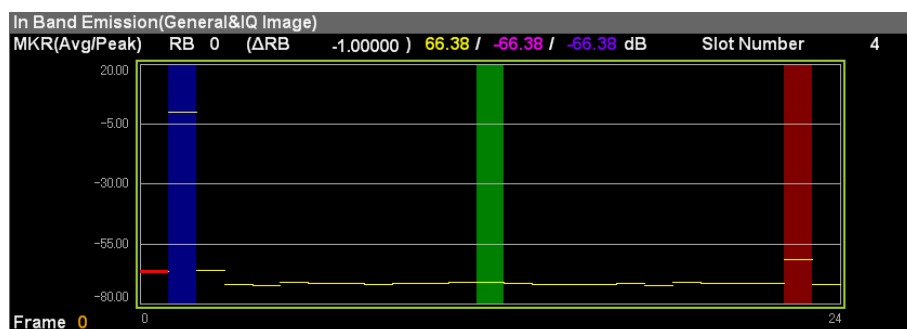

Figure 3.16-2 In-Band Emission Display (PUCCH)

Graph display

■ Summary

Displays the In-Band Emission value of the input signal. It displays the In-Band Emission value for RB.

RB selected by the marker is indicated in red.

The color bands below are displayed according to RB conditions.

- Blue: Allocated RB
- Green: Non-Allocated RB (Carrier Leakage)
- Red: Non-Allocated RB (IQ Image)
- Brown: Non-Allocated RB (Carrier Leakage + IQ Image)

 3.6.1.2 "Trace (other than Summary)"

MKR RB

■ Summary

Displays the number of the RB selected by the marker. The marker can be moved with the cursor key or the rotary knob. The average, maximum, and minimum In-Band Emission values are also displayed.

MKR Result

■ Summary

Displays the average, maximum, and minimum In-Band Emission of the marker-selected RBs.

Slot Number

■ Summary

Displays the Bottom Graph Slot Number set in In-Band Emission.

Note:

This is displayed when In-Band EmissionView is Each Slot.

Δ RB

■ Summary

Displays the distance from Allocate RB to each RB.

3.17 Summary

Displays a list of numerical results for each measurement.

The EVM, In-Band Emission, and SpectralFlatness measurement results are displayed on multiple pages. The displayed measurement results differ according to the measurement target Channel (specified for TargetChannel).

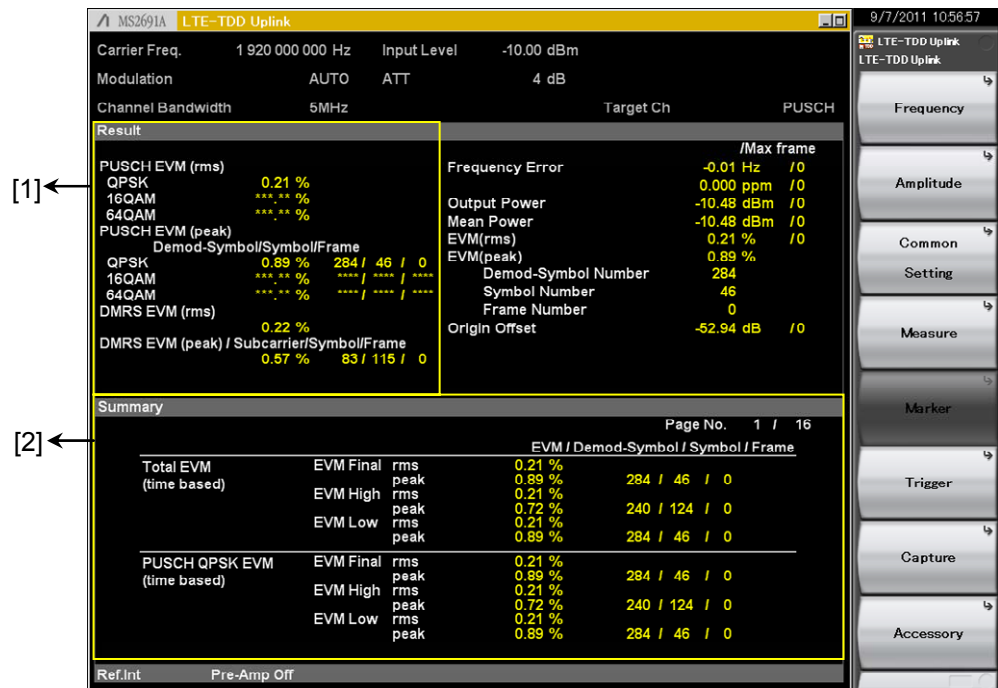

Figure 3.17-1 Summary

<Description of display area [1]>

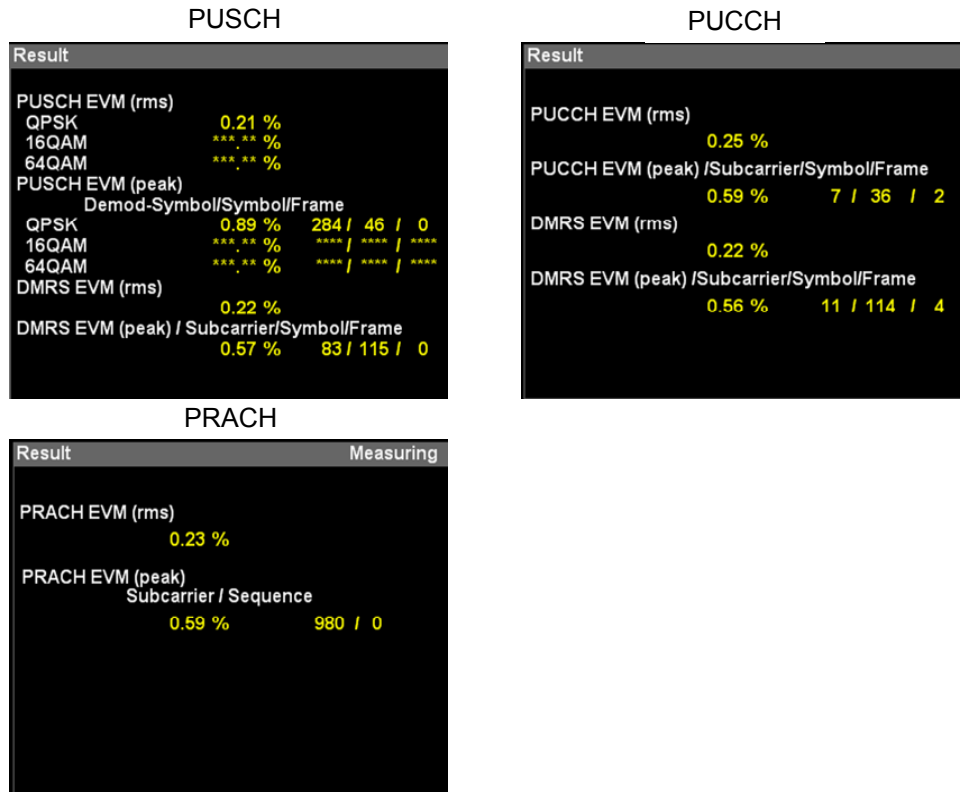

Figure 3.17-2 Description of display area [1]

When TargetChannel is PUSCH

PUSCH EVM (rms) * Displays the Final result of TimeBase.

QPSK

16QAM

64QAM

PUSCH EVM(peak)/ /Demod-Symbol/Symbol/Frame

* Displays the Final result of TimeBase.

QPSK

16QAM

64QAM

DMRS EVM (rms) * Displays the Final result of RS.

DMRS EVM (peak)/Subcarrier/Symbol/Frame

* Displays the Final result of DMRS.

When TargetChannel is PUCCH

PUCCH EVM (rms) * Displays the Final result of PUCCH.

PUCCH EVM (peak)/Subcarrier/Symbol/Frame

* Displays the Final result of PUCCH.

DMRS EVM (rms) * Displays the Final result of RS.

DMRS EVM (peak)/Subcarrier/Symbol/Frame

* Displays the Final result of DMRS.

When TargetChannel is PRACH

PRACH EVM (rms) * Displays the Final result of PRACH.

PRACH EVM (peak)/Subcarrier/Sequence

* Displays the Final result of PRACH.

<Description of display area [2]>

The displayed result items and number of displayed pages differ according to each Target Channel setting as follows. For details about measurement results, see Appendix D.

Table 3.17-1 <Description of display area [2]>

Page No.	Target Ch PUSCH	Target Ch PUCCH	Target Ch PRACH
1	Total EVM (time based) PUSCH QPSK EVM (time based)	Total EVM PUCCH EVM	PRACH EVM
2	PUSCH 16QAM EVM (time based) PUSCH 64QAM EVM (time based)	DMRS EVM	
3	Total EVM (Frequency Based) PUSCH All EVM	Frequency Error vs Slot (1/4)	
4	PUSCH QPSK EVM PUSCH 16QAM EVM	Frequency Error vs Slot (2/4)	
5	PUSCH 64QAM EVM DMRS EVM	Frequency Error vs Slot (3/4)	
6	Frequency Error vs Slot (1/4)	Frequency Error vs Slot (4/4)	
7	Frequency Error vs Slot (2/4)	Origin Offset vs Slot (1/2)	
8	Frequency Error vs Slot (3/4)	Origin Offset vs Slot (2/2)	
9	Frequency Error vs Slot (4/4)	In-Band Emission	
10	Origin Offset vs Slot (1/2)	In-Band Emission (Margin Peak)	
11	Origin Offset vs Slot (2/2)	Spectral Flatness	
12	In- Band Emission	Spectral Flatness (peak to peak) normal condition	
13	In- Band Emission (Margin Peak)	Spectral Flatness (peak to peak) extreme condition	
14	Spectral Flatness		
15	Spectral Flatness (peak to peak) normal condition		
16	Spectral Flatness (peak to peak) extreme condition		

3.17.1 PUSCH SUMMARY

PUSCH SUMMARY

Page 1, 2

PUSCH EVM (time based)

Summary				Page No. 1 / 16		
				EVM / Demod-Symbol / Symbol / Frame		
Total EVM (time based)	EVM Final	rms	0.21 %	284 / 46 / 0		
		peak	0.89 %			
	EVM High	rms	0.21 %	240 / 124 / 0		
		peak	0.72 %			
EVM Low	rms	0.21 %	284 / 46 / 0			
	peak	0.89 %				
PUSCH QPSK EVM (time based)	EVM Final	rms	0.21 %	284 / 46 / 0		
		peak	0.89 %			
	EVM High	rms	0.21 %	240 / 124 / 0		
		peak	0.72 %			
	EVM Low	rms	0.21 %	284 / 46 / 0		
		peak	0.89 %			
Summary				Page No. 2 / 16		
				EVM / Demod-Symbol / Symbol / Frame		
PUSCH 16QAM EVM (time based)	EVM Final	rms	0.23 %	283 / 32 / 0		
		peak	1.03 %			
	EVM High	rms	0.22 %	95 / 44 / 0		
		peak	1.03 %			
EVM Low	rms	0.23 %	283 / 32 / 0			
	peak	1.03 %				
PUSCH 64QAM EVM (time based)	EVM Final	rms	*** ** %	*** / *** / ***		
		peak	*** ** %			
	EVM High	rms	*** ** %	*** / *** / ***		
		peak	*** ** %			
	EVM Low	rms	*** ** %	*** / *** / ***		
		peak	*** ** %			

Figure 3.17.1-1 PUSCH EVM (time based)

■ Summary

Displays the EVM data for the time domain of each channel of the input signal.

EVM Final	The worse EVM values of either EVM High or EVM Low.
EVM High	The EVM value calculated in high side of the FFT Window (EVM Window Length).
EVM Low	The EVM value calculated in low side of the FFT Window (EVM Window Length).
EVM rms	EVM (RMS)
EVM peak	EVM peak
Demod-Symbol	EVM peak position information in Demod-Symbol units
Symbol	EVM peak position information in Symbol units
Frame	EVM peak position information in Frame units

■ Measurement Result Types

Total EVM
PUSCH QPSK EVM
PUSCH 16QAM EVM
PUSCH 64QAM EVM

Page 3, 4, 5

EVM of PUSCH (Frequency Based)

Summary				Page No. 3 / 16		
				EVM / Subcarrier / Symbol / Frame		
Total EVM (Frequency Based)	EVM Final	rms	0.22 %	263 / 44 / 0		
		peak	0.83 %			
	EVM High	rms	0.22 %			
		peak	0.81 %			
	EVM Low	rms	0.22 %			
		peak	0.83 %			
PUSCH All EVM	EVM Final	rms	0.23 %	263 / 44 / 0		
		peak	0.83 %			
	EVM High	rms	0.22 %			
		peak	0.81 %			
	EVM Low	rms	0.23 %			
		peak	0.83 %			

Summary				Page No. 4 / 16		
				EVM / Subcarrier / Symbol / Frame		
PUSCH QPSK EVM	EVM Final	rms	0.21 %	34 / 41 / 0		
		peak	0.74 %			
	EVM High	rms	0.21 %			
		peak	0.73 %			
	EVM Low	rms	0.21 %			
		peak	0.74 %			
PUSCH 16QAM EVM	EVM Final	rms	***.xx %	**** / *** / ***		
		peak	***.xx %			
	EVM High	rms	***.xx %			
		peak	***.xx %			
	EVM Low	rms	***.xx %			
		peak	***.xx %			

Summary				Page No. 5 / 16		
				EVM / Subcarrier / Symbol / Frame		
PUSCH 64QAM EVM	EVM Final	rms	***.xx %	**** / *** / ***		
		peak	***.xx %			
	EVM High	rms	***.xx %			
		peak	***.xx %			
	EVM Low	rms	***.xx %			
		peak	***.xx %			
DMRS EVM	EVM Final	rms	0.21 %	234 / 122 / 0		
		peak	0.49 %			
	EVM High	rms	0.21 %			
		peak	0.49 %			
	EVM Low	rms	0.21 %			
		peak	0.49 %			

Figure 3.17.1-2 PUSCH EVM (Frequency Based)

■ Summary

Displays the EVM of the input signal for each channel.

- EVM Final The worse EVM values of either EVM High or EVM Low.
- EVM High The EVM value calculated in high side of the FFT Window (EVM Window Length).
- EVM Low The EVM value calculated in low side of the FFT Window (EVM Window Length).
- EVM rms EVM (RMS)
- EVM peak EVM peak
- Subcarrier EVM peak position information in Subcarrier units
- Symbol EVM peak position information in Symbol units
- Frame EVM peak position information in Frame units

■ Measurement Result Types

Total EVM

PUSCH All EVM

PUSCH QPSK EVM

PUSCH 16QAM EVM

PUSCH 64QAM EVM

DMRS EVM

Page 6, 7, 8, 9

Frequency Error vs Slot of PUSCH

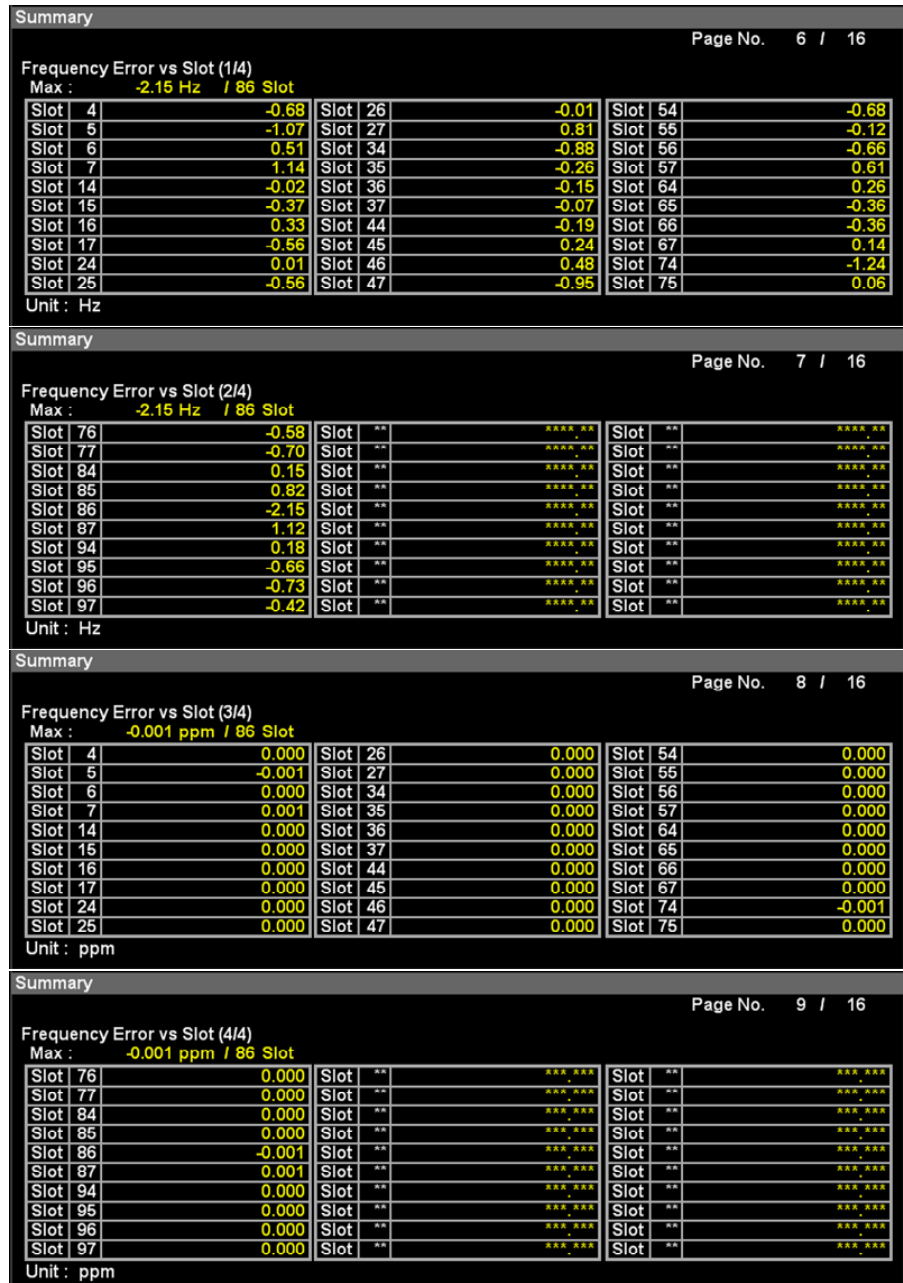

Figure 3.17.1-3 PUSCH Frequency Error vs Slot

■ Summary

Displays frequency error of input signal for each slot.

Page 10, 11

Origin Offset vs Slot of PUSCH

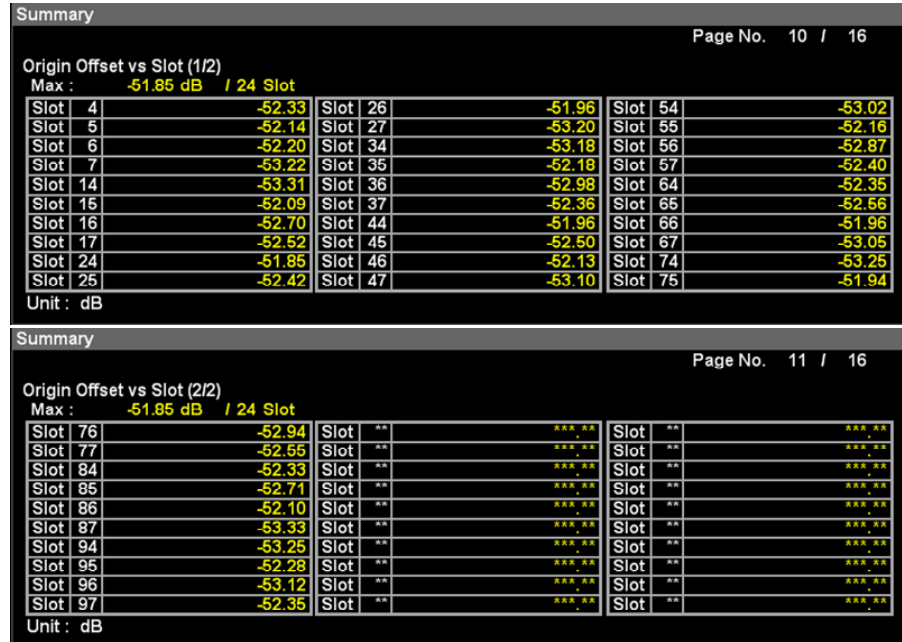

3

Measurement

Figure 3.17.1-4 PUSCH Origin Offset vs Slot

■ Summary

Displays origin offset of input signal for each slot.

Page 12
In-Band Emission of PUSCH

Summary				Page No. 12 / 16
				RB / Slot / Frame
General	In-Band	Emission (Avg)	-69.30 dB	24 / 6 / 0
		Emission (Peak)	-59.54 dB	
		Power	-70.61 dBm	
IQ Image	In-Band	Emission (Avg)	-59.75 dB	24 / 6 / 0
		Emission (Peak)	-59.54 dB	
		Power	-70.61 dBm	
Carrier Leakage	In-Band	Emission (Avg)	-71.96 dB	12 / 15 / 0
		Emission (Peak)	-71.40 dB	
		Power	-82.47 dBm	
General (Excl. IQ/CL)	In-Band	Emission (Avg)	-71.12 dB	1 / 14 / 0
		Emission (Peak)	-62.70 dB	
		Power	-73.77 dBm	

Figure 3.17.1-5 PUSCH In-Band Emission

■ Summary

Displays the numeric results for Emission measurement items.

- Emission (Avg) Average value within the Measurement Interval [dB]
- Emission (Peak) Maximum value within the Measurement Interval [dB]
- Power: Power absolute value of Emission (Peak) [dBm]
- RB Position information of Emission (Peak) in RB units
- Slot Position information of Emission (Peak) in Slot units
- Frame Position information of Emission (Peak) in Frame units

■ Measurement Result Types

- General
- IQ Image
- Carrier Leakage
- General (Exclude IQ/ Carrier Leakage)

In-Band Emission (Margin Peak) of PUSCH

Summary		Page No. 13 / 16		
		RB / Slot / Frame		
In-Band Emission General	Margin Peak Spec Value Spec Type	-59.66 dB -24.03 dB Power (General + IQ Image)	24	6 / 0
In-Band Emission IQ Image	Margin Peak Spec Value Spec Type	-59.66 dB -24.03 dB Power (General + IQ Image)	24	6 / 0
In-Band Emission Carrier Leakage	Margin Peak Spec Value Spec Type	-71.22 dB -19.15 dB Power (General + Carrier leakage)	12	15 / 0
In-Band Emission General(Excl. IQ/CL)	Margin Peak Spec Value Spec Type	-70.51 dB -29.20 dB P_RB - 30[dB]	14	4 / 0

Figure 3.17.1-6 PUSCH In-Band Emission (Margin Peak)

■ Summary

Displays the results of margins relative to the limit for Emission measurement items.

- Margin Peak Minimum Emission value relative to the limit within the Measurement Interval or maximum Emission value which exceeds the limit [dB]
- RB Margin Peak position information in RB units
- Slot Margin Peak position information in Slot units
- Frame Margin Peak position information in Frame units
- Spec Value Specification limit value [dB]
- Spec Type Specification type [dB]

■ Measurement Result Types

- General
- IQ Image
- Carrier Leakage
- General (Exclude IQ/ Carrier Leakage)

Summary		Page No. 14 / 16		
		Subcarrier / Slot / Frame		
Inside Flatness (≥3 MHz)	Flatness (Avg)	0.00 dB		
	Flatness (Max)	0.06 dB	75	15 / 0
	Flatness (Min)	-0.07 dB	149	17 / 4
Outside Flatness (<3 MHz)	Flatness (Avg)	*** ** dB	****	1 ** / ****
	Flatness (Max)	*** ** dB	****	1 ** / ****
	Flatness (Min)	*** ** dB	****	1 ** / ****
Inside Flatness (≥5 MHz)	Flatness (Avg)	0.00 dB		
	Flatness (Max)	0.06 dB	75	15 / 0
	Flatness (Min)	-0.07 dB	149	17 / 4
Outside Flatness (<5 MHz)	Flatness (Avg)	*** ** dB	****	1 ** / ****
	Flatness (Max)	*** ** dB	****	1 ** / ****
	Flatness (Min)	*** ** dB	****	1 ** / ****

Figure 3.17.1-7 PUSCH Spectral Flatness

■ Summary

Displays Inside Flatness (>3 MHz, 5 MHz) and Outside Flatness (<3 MHz, 5 MHz).

Flatness (Avg) Average [dB]

Flatness (Max) Maximum value [dB]

Flatness (Min) Minimum value [dB]

Subcarrier Flatness (Max) position information in Subcarrier units
Flatness (Min) position information in Subcarrier units

Slot Flatness (Max) position information in Slot units
Flatness (Min) position information in Slot units

Frame Flatness (Max) position information in Frame units
Flatness (Min) position information in Frame units

The Inside Flatness and Outside Flatness measurement results are calculated according to the Carrier Frequency and Operating Band values.

 3.2 “Setting Frequency”

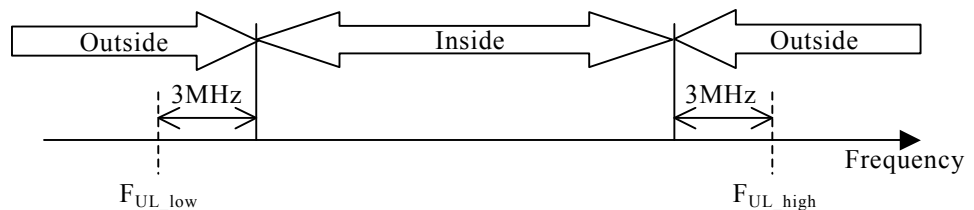

Figure 3.17.1-8 Relationship Between Inside Flatness and Outside Flatness Areas (At 3 MHz)

■ Measurement Result Types

- Inside Flatness (≥ 3 MHz)
- Outside Flatness (< 3 MHz)
- Inside Flatness (≥ 5 MHz)
- Outside Flatness (< 5 MHz)

Page 15

Spectral Flatness (peak to peak) normal condition of PUSCH

Summary		Page No. 15 / 16
		Slot / Frame
EVM equalizer spectrum flatness (normal condition)	RP_11 (Avg) (Max)	0.01 dB 0.02 dB 17 / 0
EVM equalizer spectrum flatness (normal condition)	RP_22 (Avg) (Max)	*** ** dB *** ** dB **** / ***
EVM equalizer spectrum flatness (normal condition)	RP_12 (Avg) (Max)	*** ** dB *** ** dB **** / ***
EVM equalizer spectrum flatness (normal condition)	RP_21 (Avg) (Max)	*** ** dB *** ** dB **** / ***

Figure 3.17.1-9 PUSCH Spectral Flatness (peak to peak) normal condition

■ Summary

Displays the result of peak to peak of Spectral Flatness (Amplitude) in Normal condition.

- RP11: Maximum ripple of Range1
- RP22: Maximum ripple of Range2
- RP12: Maximum ripple between the maximum of Range1 and minimum of Range2
- RP21: Maximum ripple between the maximum of Range2 and minimum of Range1
- RP_11 (Avg) Average of RP11 [dB]
- (Max) Maximum of RP11 [dB]
- RP_22 (Avg) Average of RP22 [dB]
- (Max) Maximum of RP22 [dB]
- RP_12 (Avg) Average of RP12 [dB]
- (Max) Maximum of RP12 [dB]
- RP_21 (Avg) Average of RP21 [dB]
- (Max) Maximum of RP21 [dB]
- Slot (Max) position information of each RP in Slot units
- Frame (Max) position information of each RP in Frame units

3
Measurement

Summary		Page No. 16 / 16
		Slot / Frame
EVM equalizer spectrum flatness (extreme condition)	RP_11 (Avg) (Max)	0.01 dB 0.02 dB 17 / 0
EVM equalizer spectrum flatness (extreme condition)	RP_22 (Avg) (Max)	***. ** dB ***. ** dB **** / ***
EVM equalizer spectrum flatness (extreme condition)	RP_12 (Avg) (Max)	***. ** dB ***. ** dB **** / ***
EVM equalizer spectrum flatness (extreme condition)	RP_21 (Avg) (Max)	***. ** dB ***. ** dB **** / ***

Figure 3.17.1-10 PUSCH Spectral Flatness (peak to peak) extreme condition

■ Summary

Displays the result of peak to peak of Spectral Flatness (Amplitude) in Extreme condition.

RP11: Maximum ripple of Range1

RP22: Maximum ripple of Range2

RP12: Maximum ripple between the maximum of Range1 and minimum of Range2

RP21: Maximum ripple between the maximum of Range2 and minimum of Range1

RP_11 (Avg) Average of RP11 [dB]
(Max) Maximum of RP11 [dB]

RP_22 (Avg) Average of RP22 [dB]
(Max) Maximum of RP22 [dB]

RP_12 (Avg) Average of RP12 [dB]
(Max) Maximum of RP12 [dB]

RP_21 (Avg) Average of RP21 [dB]
(Max) Maximum of RP21 [dB]

Slot (Max) position information of each RP in Slot units

Frame (Max) position information of each RP in Frame units

3.17.2 PUCCH SUMMARY

PUCCH SUMMARY

Page 1, 2

EVM of PUCCH

Summary				Page No. 1 / 13		
				EVM / Subcarrier / Symbol / Frame		
Total EVM	EVM Final	rms	0.23 %	7 / 36 / 2		
		peak	0.59 %			
	EVM High	rms	0.22 %	9 / 117 / 4		
		peak	0.58 %			
	EVM Low	rms	0.23 %	7 / 36 / 2		
		peak	0.59 %			
PUCCH EVM	EVM Final	rms	0.25 %	7 / 36 / 2		
		peak	0.59 %			
	EVM High	rms	0.23 %	9 / 117 / 4		
		peak	0.58 %			
	EVM Low	rms	0.25 %	7 / 36 / 2		
		peak	0.59 %			

Summary				Page No. 2 / 13		
				EVM / Subcarrier / Symbol / Frame		
DMRS EVM	EVM Final	rms	0.22 %	11 / 114 / 4		
		peak	0.56 %			
	EVM High	rms	0.22 %	9 / 108 / 2		
		peak	0.57 %			
	EVM Low	rms	0.22 %	11 / 114 / 4		
		peak	0.56 %			

3

Measurement

Figure 3.17.2-1 PUCCH EVM

■ Summary

Displays the EVM values of PUCCH input.

EVM High The EVM value calculated in high side of the FFT Window (EVM Window Length).

EVM Low The EVM value calculated in low side of the FFT Window (EVM Window Length).

EVM Final The worse EVM values of either EVM High or EVM Low.

EVM rms EVM (RMS)

EVM peak EVM peak

Subcarrier EVM peak position information in Subcarrier units

Symbol EVM peak position information in Symbol units

Frame EVM peak position information in Frame units

■ Measurement Result Types

Total EVM, PUCCH EVM, DMRS EVM

Page 3, 4, 5, 6

Frequency Error vs Slot of PUCCH

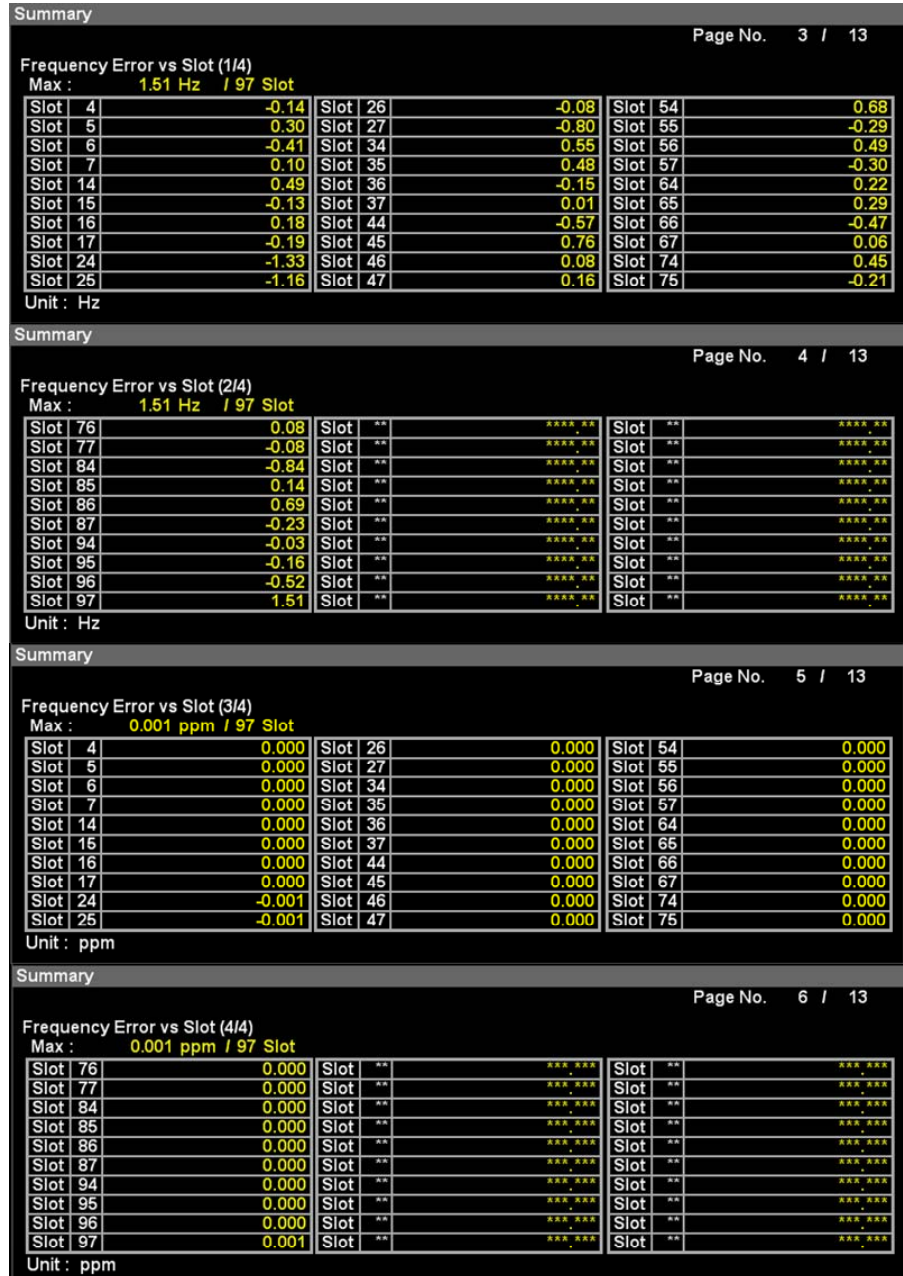

Figure 3.17.2-2 PUCCH Frequency Error vs Slot

■ Summary

Displays frequency error of input signal for each slot.

Page 7, 8

Origin Offset vs Slot of PUCCH

Summary				Page No. 7 / 13	
Origin Offset vs Slot (1/2)					
Max : -44.41 dB / 94 Slot					
Slot 4	-44.43	Slot 26	-44.55	Slot 54	-44.56
Slot 5	-44.52	Slot 27	-44.51	Slot 55	-44.51
Slot 6	-44.41	Slot 34	-44.55	Slot 56	-44.45
Slot 7	-44.50	Slot 35	-44.46	Slot 57	-44.51
Slot 14	-44.55	Slot 36	-44.45	Slot 64	-44.50
Slot 15	-44.52	Slot 37	-44.48	Slot 65	-44.54
Slot 16	-44.50	Slot 44	-44.45	Slot 66	-44.53
Slot 17	-44.55	Slot 45	-44.56	Slot 67	-44.53
Slot 24	-44.50	Slot 46	-44.48	Slot 74	-44.42
Slot 25	-44.56	Slot 47	-44.49	Slot 75	-44.49
Unit : dB					

Summary				Page No. 8 / 13	
Origin Offset vs Slot (2/2)					
Max : -44.41 dB / 94 Slot					
Slot 76	-44.41	Slot **	*** **	Slot **	*** **
Slot 77	-44.53	Slot **	*** **	Slot **	*** **
Slot 84	-44.60	Slot **	*** **	Slot **	*** **
Slot 85	-44.54	Slot **	*** **	Slot **	*** **
Slot 86	-44.55	Slot **	*** **	Slot **	*** **
Slot 87	-44.50	Slot **	*** **	Slot **	*** **
Slot 94	-44.41	Slot **	*** **	Slot **	*** **
Slot 95	-44.51	Slot **	*** **	Slot **	*** **
Slot 96	-44.51	Slot **	*** **	Slot **	*** **
Slot 97	-44.52	Slot **	*** **	Slot **	*** **
Unit : dB					

3
Measurement

Figure 3.17.2-3 PUCCH Origin Offset vs Slot

■ Summary

Displays origin offset of input signal for each slot.

Page 9

In-Band Emission of PUCCH

Summary				Page No. 9 / 13		
RB / Slot / Frame						
General	In-Band	Emission (Avg)	-66.31 dB	23	/	6 / 3
		Emission (Peak)	-53.49 dB			
		Power	-63.00 dBm			
IQ Image	In-Band	Emission (Avg)	-56.33 dB	23	/	6 / 3
		Emission (Peak)	-53.49 dB			
		Power	-63.00 dBm			
Carrier Leakage	In-Band	Emission (Avg)	-70.87 dB	12	/	14 / 0
		Emission (Peak)	-70.00 dB			
		Power	-79.52 dBm			
General (Excl. IQ/CL)	In-Band	Emission (Avg)	-68.38 dB	0	/	16 / 3
		Emission (Peak)	-58.21 dB			
		Power	-67.72 dBm			

Figure 3.17.2-4 PUCCH In-Band Emission

■ Summary

Same as the Summary for PUSCH in Page 6.

Page 10

In-Band Emission of PUCCH (Margin Peak)

Summary		Page No. 10 / 13		
		RB / Slot / Frame		
In-Band Emission General	Margin Peak	-53.49 dB	23	6 / 3
	Spec Value	-24.03 dB		
	Spec Type	Power (General + IQ Image)		
In-Band Emission IQ Image	Margin Peak	-53.49 dB	23	6 / 3
	Spec Value	-24.03 dB		
	Spec Type	Power (General + IQ Image)		
In-Band Emission Carrier Leakage	Margin Peak	-70.00 dB	12	14 / 0
	Spec Value	-19.15 dB		
	Spec Type	Power (General + Carrier leakage)		
In-Band Emission General(Excl. IQ/CL)	Margin Peak	-58.21 dB	0	16 / 3
	Spec Value	-21.34 dB		
	Spec Type	Power (General)		

Figure 3.17.2-5 PUCCH In-Band Emission (Margin Peak)

■ Summary

Same as the Summary for PUSCH in Page 7.

Page 11

Spectral Flatness of PUCCH

Summary		Page No. 11 / 13		
		Subcarrier / Slot / Frame		
Inside Flatness (≥3 MHz)	Flatness (Avg)	0.00 dB		
	Flatness (Max)	0.01 dB	12	14 / 4
	Flatness (Min)	-0.01 dB	18	16 / 1
Outside Flatness (<3 MHz)	Flatness (Avg)	*** ** dB		
	Flatness (Max)	*** ** dB	****	** / ***
	Flatness (Min)	*** ** dB	****	** / ***
Inside Flatness (≥5 MHz)	Flatness (Avg)	0.00 dB		
	Flatness (Max)	0.01 dB	12	14 / 4
	Flatness (Min)	-0.01 dB	18	16 / 1
Outside Flatness (<5 MHz)	Flatness (Avg)	*** ** dB		
	Flatness (Max)	*** ** dB	****	** / ***
	Flatness (Min)	*** ** dB	****	** / ***

Figure 3.17.2-6 PUCCH Spectral Flatness

■ Summary

Same as the Summary for PUSCH in Page 8.

Page 12

Spectral Flatness (peak to peak) normal condition of PUCCH

Summary		Page No. 12 / 13	
		Slot / Frame	
EVM equalizer spectrum flatness (normal condition)	RP_11 (Avg) (Max)	0.02 dB 0.02 dB	14 / 4
EVM equalizer spectrum flatness (normal condition)	RP_22 (Avg) (Max)	*** ** dB *** ** dB	**** / ***
EVM equalizer spectrum flatness (normal condition)	RP_12 (Avg) (Max)	*** ** dB *** ** dB	**** / ***
EVM equalizer spectrum flatness (normal condition)	RP_21 (Avg) (Max)	*** ** dB *** ** dB	**** / ***

Figure 3.17.2-7 PUCCH Spectral Flatness (peak to peak) normal condition

■ Summary

Same as the Summary for PUSCH in Page 9.

Page 13

Spectral Flatness (peak to peak) extreme condition of PUCCH

Summary		Page No. 13 / 13	
		Slot / Frame	
EVM equalizer spectrum flatness (extreme condition)	RP_11 (Avg) (Max)	0.02 dB 0.02 dB	14 / 4
EVM equalizer spectrum flatness (extreme condition)	RP_22 (Avg) (Max)	*** ** dB *** ** dB	**** / ***
EVM equalizer spectrum flatness (extreme condition)	RP_12 (Avg) (Max)	*** ** dB *** ** dB	**** / ***
EVM equalizer spectrum flatness (extreme condition)	RP_21 (Avg) (Max)	*** ** dB *** ** dB	**** / ***

Figure 3.17.2-8 PUCCH Spectral Flatness (peak to peak) extreme condition

■ Summary

Same as the Summary for PUSCH in Page 10.

3.17.3 PRACH SUMMARY

PRACH SUMMARY

EVM of PRACH

Summary				Page No. 1 / 1
				EVM / Subcarrier / Sequence
PRACH EVM	EVM Final	rms	0.16 %	1001 / 0
		peak	0.32 %	
EVM High	EVM High	rms	0.16 %	1041 / 0
		peak	0.30 %	
EVM Low	EVM Low	rms	0.16 %	1001 / 0
		peak	0.32 %	

Figure 3.17.3-1 PRACH EVM

■ Summary

Displays the EVM values of PRACH input.

EVM Final The worse EVM values of either EVM High or EVM Low.

EVM High The EVM value calculated in high side of the FFT Window (EVM Window Length).

EVM Low The EVM value calculated in low side of the FFT Window (EVM Window Length).

EVM (Avg) Average of EVM

EVM (Peak) Maximum of EVM

Subcarrier EVM (Peak) position information in Subcarrier units

Sequence EVM (Peak) position information in Sequence units

■ Measurement Result Types

PRACH EVM

3.18 Power vs Time Display

Displays the measurement results of Power vs Time.



3
Measurement

Figure 3.18-1 The display of Power vs Time

<Description of display area [1]>

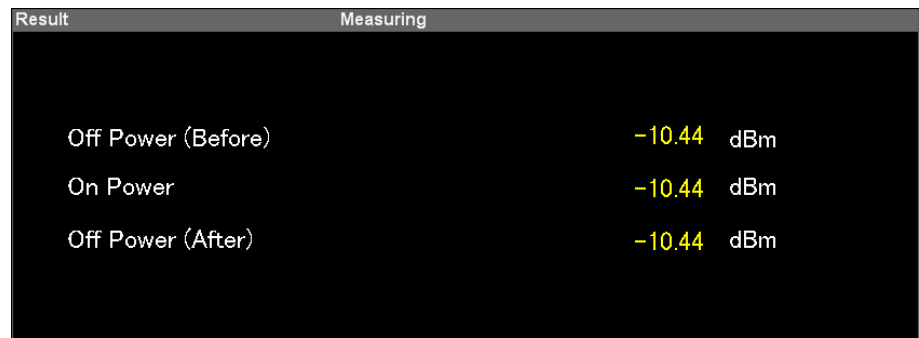

Figure 3.18-2 Power vs Time (PUSCH / PUCCH / PRACH)

Off Power (Before)

■ Summary

Displays the power in the Off area before the On area starts. The transient period is excluded.

On Power

■ Summary

Displays the power in the On area. The transient period is excluded.

Off Power (After)

■ Summary

Displays the power in the Off area after the On area ends. The transient period is excluded.

3.19 Power vs Time - Burst

Displays the measurement results of Power vs Time - Burst. The waveform around the On area is plotted.

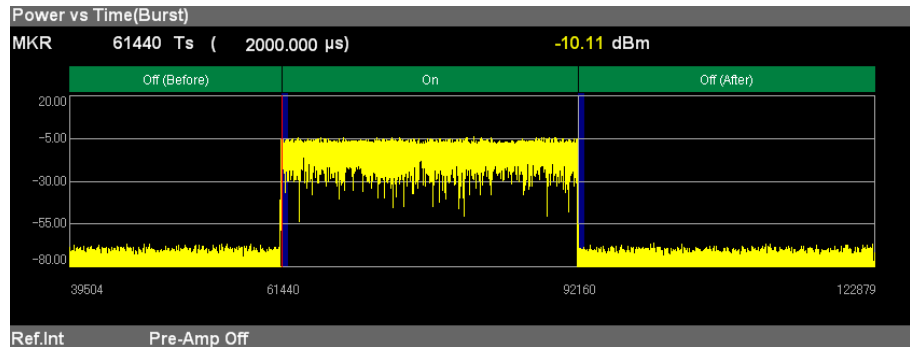

Figure 3.19-1 Power vs Time - Burst (PUSCH / PUCCH)

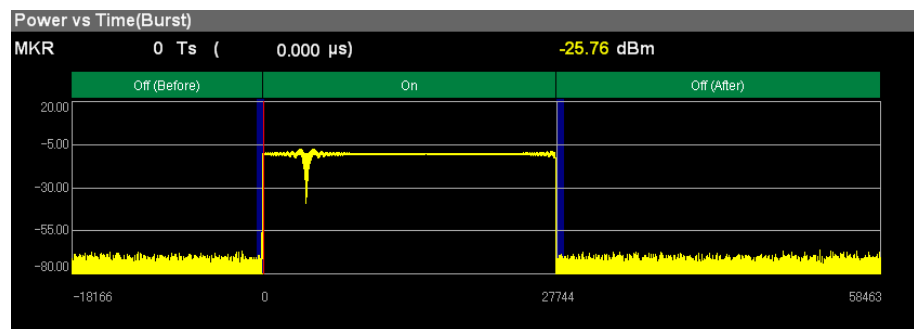

Figure 3.19-2 Power vs Time - Burst (PRACH)

Graph display

■ Summary

Displays Power [dBm] (Y axis) for each sample number [Ts] (X axis).

The transient period is displayed in blue band.

MKR Ts

■ Summary

Displays the sample number selected by marker. The marker can be moved with the cursor key or the rotary knob.

MKR Result

■ Summary

Displays the sample power selected by marker.

3.20 Power vs Time - Transient

Displays the measurement results of Power vs Time - Transient. The areas around the waveform rising and falling are plotted.

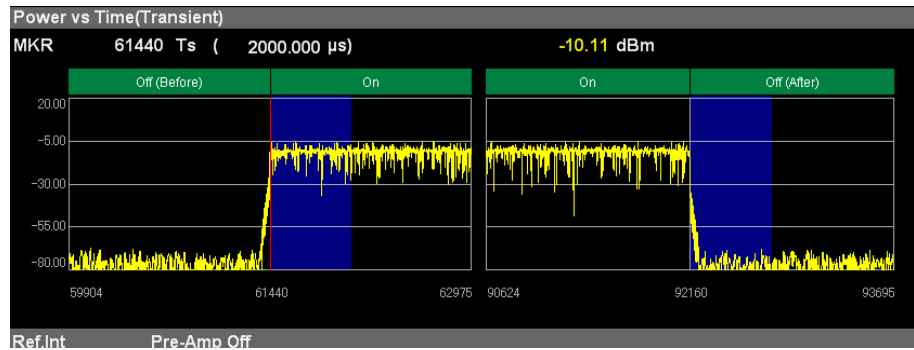

Figure 3.20-1 Power vs Time - Transient (PUSCH / PUCCH)

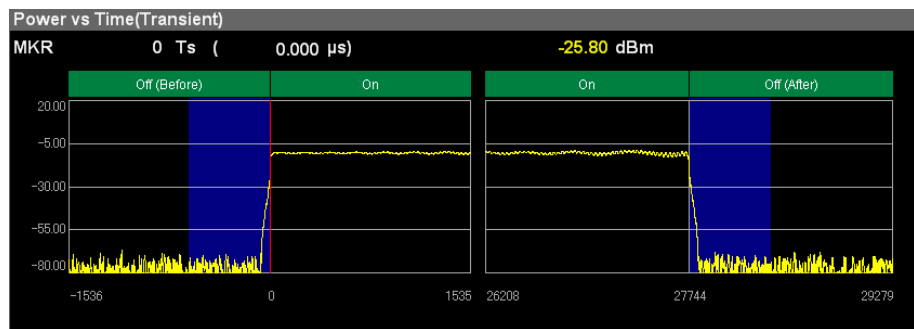

Figure 3.20-2 Power vs Time - Transient (PRACH)

Graph display

■ Summary

Displays Power [dBm] (Y axis) for each sample number [Ts] (X axis).

The transient period is displayed in blue band.

MKR Ts

■ Summary

Displays the sample number selected by marker. The marker can be moved with the cursor key or the rotary knob.

MKR Result

■ Summary

Displays the sample power selected by marker.

3.21 Saving Measurement Results

Saves measurement results to the internal hard disk or USB memory. Press  with the 3G LTE Uplink screen open to display the Save function menu.

Note:

Use the USB memory supplied. Other USB memory may malfunction due to incompatibilities.

Table 3.21-1 Save function menu

Function Keys	Menu Display	Function
F1	Device	Sets the save destination drive.
F7	Save Application	Sets measurement parameters.  MS2690A/MS2691A/MS2692A or MS2830A Signal Analyzer operation manual
F8	Close	Closes the Save function menu.

Device

■ Summary

Sets the save destination drive.

■ Options

D, E, F, ...

All drives except for C

Close

■ Summary

Close the Save function menu.

Chapter 4 Digitize Function

This chapter describes how to save IQ data to an external memory and replay the stored IQ data.

4.1	Saving IQ Data.....	4-2
4.1.1	Format of data information file.....	4-4
4.1.2	Format of data file.....	4-6
4.2	Replay Function.....	4-7
4.2.1	Starting Replay Function	4-8
4.2.2	Display during Replay Function Execution....	4-8
4.2.3	Restriction during Replay Function Execution.....	4-9
4.2.4	Conditions for IQ Data Files That Can Be Replayed	4-9
4.2.5	Stopping Replay	4-10

4.1 Saving IQ Data



After pressing  (Capture) on the main function menu, press  (Save Captured Data) to display the Save Captured Data function menu.





Table 4.1-1 Save Captured Data function menu

Function Key	Menu Display	Function
F1	Device	Selects the location of the file to be saved.
F2	File Name	Sets the name of the file to be saved.
F3	Output Rate	Sets the rate of the output data.
F7	Exec Digitize	Executes saving.
F8	Close	Closes the Save Captured Data function menu.

The IQ data stored in the internal memory at the time of execution of this function is saved to the external memory.

Example: To save IQ data

<Procedure>

1. Press  (Capture) on the main function menu.
2. Press  (Save Captured Data).
3. Press  (Device) on the Save Captured Data function menu to select a data file for saving the IQ data.
4. Press  (File Name) to set the file name.
5. Press  (Exec Digitize) to save the IQ data.

When save processing is executed, the following files are created.

- “[File Name].dgz” Data file (binary format)
- “[File Name].xml” Data information file (XML format)

The IQ data row is saved to the data file. The information on the saved data is saved to the data information file.

If a file name was not specified, the file is automatically named “Digitize *date_sequential number*”. The sequential number range is from 0 to 999.

Files are saved to the following directory of the target drive specified using  (Device).

\Anritsu Corporation\Signal Analyzer\User Data\Digitized
Data\LTE-TDD Uplink

Up to 100 files can be saved in a folder.

4.1.1 Format of data information file

The information on the saved IQ data is recorded in the data information file. Table 4.1.1-1 shows the details of the recorded parameters.

Table 4.1.1-1 Format of data information file

Item	Descriptions
CaptureDate	Day/Month/Year of the captured data in the “DD/MM/YYYY” format.
CaptureTime	Data captured time in “HH/MM/SS” format
FileName	Data file name
Format	Data format, fixed to “Float”
CaptureSample	Number of samples of the recorded data [Sample]
Condition	Error status of the recorded data “Normal”:No error “OverLoad”:Level over
TriggerPosition	Trigger occurrence position [Sample] The start point of the recorded data is 0.
CenterFrequency	Center frequency [Hz]
SpanFrequency	Frequency span [Hz]
SamplingClock	Sampling rate [Hz]
PreselectorBandMode	Frequency band switch mode “Normal”: Normal mode (fixed)
ReferenceLevel	Reference level [dBm] Note that this value does not include the reference level offset.
AttenuatorLevel	Attenuator value [dB]
InternalGain	Internal gain value [dB] This is an internal parameter.
PreAmp	Gain value obtained by Option 008 [dB]
IQReverse	IQ reverse setting, fixed to “Normal”
TriggerSwitch	Trigger On/Off setting “FreeRun”:Trigger is not used. “Triggered”:Trigger is used.

Table 4.1.1-1 Format of data information file (Cont'd)

Item	Descriptions
TriggerSource	Trigger source “External”: External trigger “SGMarker”: SG marker trigger
TriggerLevel	Trigger level [dBm] Note that this value does not include the reference level offset. It is in dBm units, even if the scale mode is Lin.
TriggerDelay	Trigger delay time [s] It is the relative time from the trigger input position to the start point of the recorded data.
IQReference0dBm	Reference IQ amplitude value that indicates 0 dB Fixed to “1”.
ExternalReferenceDisp	Reference signal information “Ref.Int”: Internal reference signal “Ref.Ext”: External reference signal “Ref.Int Unlock”: Internal reference signal is unlocked. “Ref.Ext Unlock”: External reference signal is unlocked.
CorrectionFactor	Correction value of correction function [dB] The correction factor is added to the IQ data in a data file. 0.000 is automatically set when the Correction function is set to Off.
Terminal	Signal input terminal “RF”: RF terminal
ReferencePosition	0-second reference position Indicates the 0-second reference position using the digitized data point position. During Replay function execution, the reference position is displayed as 0 s.
TriggerSlope	Selects the edge where the trigger is generated (rise or fall). “Rise”: Rising edge “Fall”: Falling edge

4.1.2 Format of data file

The data file is created in binary format. From the beginning of the file, I-phase data and Q-phase data are recorded by 4 bytes. The I-phase data and Q-phase data are recorded as a float type (IEEE real*4).

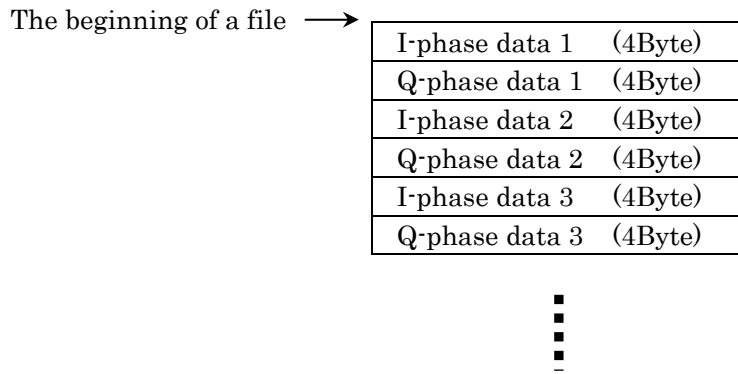

Figure 4.1.2-.1 Format of data file

The IQ data can be converted to power based on the following formula:

$$P = 10 \text{Log}_{10} (I^2 + Q^2)$$

P: Power [dBm]

I: I-phase data

Q: Q-phase data

4.2 Replay Function



The Replay function enables the saved IQ data to be reanalyzed . After pressing  (Capture) on the main function menu, press  (Replay) to display the Replay function menu.





Table 4.2-1 Replay Function Menu

Function Key	Menu Display	Function
F1	Device	Selects the drive in which the target file is stored.
F2	Application	Selects the name of the application used to save the target file.
F7	Select File	Selects the target file. After selecting the file, the Replay function is executed.
F8	Close	Closes the Replay function menu.

4.2.1 Starting Replay Function

Start the Replay function using the following procedure:

<Procedure>

1. Press  (Capture) on the main function menu.
2. Press  (Replay) on the Capture function menu.
3. Press  (Device) on the Replay function menu and select the drive in which the target file is stored.
4. Press  (Application) and select the application used to save the target file.
5. Press  (Select File) to display the file selection dialog box. The Replay function starts after a file is selected. Then, **Replaying** is displayed on the screen.

Note:

This function is executed only for an IQ data file whose sampling rate is 50 MHz.

4.2.2 Display during Replay Function Execution

Replay Error Info. is displayed if the target IQ data file meets the following conditions:

- Frequency reference is Unlocked when IQ data is saved.
- Level Over occurs when IQ data is saved.

4.2.3 Restriction during Replay Function Execution

The functions shown in Table 4.2.3-1 are disabled when Replay is executed.

Table 4.2.3-1 Functions Restricted During Replay

Function
Center Frequency
Span
Input Level
Lowest ATT Setting
Pre Amp
ACP (Swept)
Channel Power (Swept)
OBW (Swept)
Spectrum Emission Mask (Swept)
Trigger Switch
Trigger Source
Trigger Slope
Video Trigger Level
Trigger Delay
Continuous Measurement
Single Measurement
Capture Time Auto/Manual
Capture Time Length
Erase Warm Up Message

4.2.4 Conditions for IQ Data Files That Can Be Replayed

Table 4.2.4-1 shows the conditions for IQ data files for which replay analysis can be performed.



Table 4.2.4-1 IQ data file that can be replayed

Name	Value
Format	I, Q (32-bit Float Binary format)
Sampling rate	50 MHz Span 31.25MHz 100 MHz Span 62.5MHz 200 MHz Span 125MHz
Number of samples	Modulation Analysis: 3100000 or more ACP/OBW/Channel Power: 1230000 or more

4.2.5 Stopping Replay

Stop the Replay function using the following procedure:

<Procedure>

1. Press  (Capture) on the main function menu.
2. Press  (Stop Replaying) to stop the Replay function.

Chapter 5 Performance Test

This chapter describes measurement devices, setup methods, and performance test procedures required for performing performance tests as preventive maintenance.

5.1	Overview of Performance Test	5-2
5.1.1	Performance test	5-2
5.2	Performance Test Items	5-3
5.2.1	Testing methods	5-3

5.1 Overview of Performance Test

5.1.1 Performance test

Performance tests are performed as part of preventive maintenance in order to prevent the performance degradation before it occurs.

Use performance tests when required for acceptance inspection, routine inspection and performance verification after repairs. Perform items deemed critical at regular intervals as preventive maintenance. Perform the following performance tests for acceptance inspection, routine inspection and performance verification after repairs.

- Carrier frequency accuracy
- Residual EVM

Perform items deemed critical at regular intervals as preventive maintenance. A recommended cycle for routine tests of once or twice a year is desirable.

If items that do not meet the required level are detected during performance testing, contact an Anritsu Service and Sales office. Contact information can be found on the last page of the printed version of this manual, and is available in a separate file on the CD version.

5.2 Performance Test Items

Warm up the subject testing device and measuring instruments for at least 30 minutes except where directed, in order to stabilize them sufficiently before running performance tests. Demonstrating maximum measurement accuracy requires, in addition to the above, conducting performance tests under ambient temperatures, little AC power supply voltage fluctuations, as well as the absence of noise, vibrations, dust, humidity or other problems.

5.2.1 Testing methods

- (1) Test target standards
 - Carrier frequency accuracy
 - Residual vector error
- (2) Measuring instrument for tests
 - Vector signal generator
 - Frequency standard device Unnecessary if signal source has sufficient frequency accuracy
 - Power meter Unnecessary if signal source has sufficient transmitter power accuracy

(3) Setup

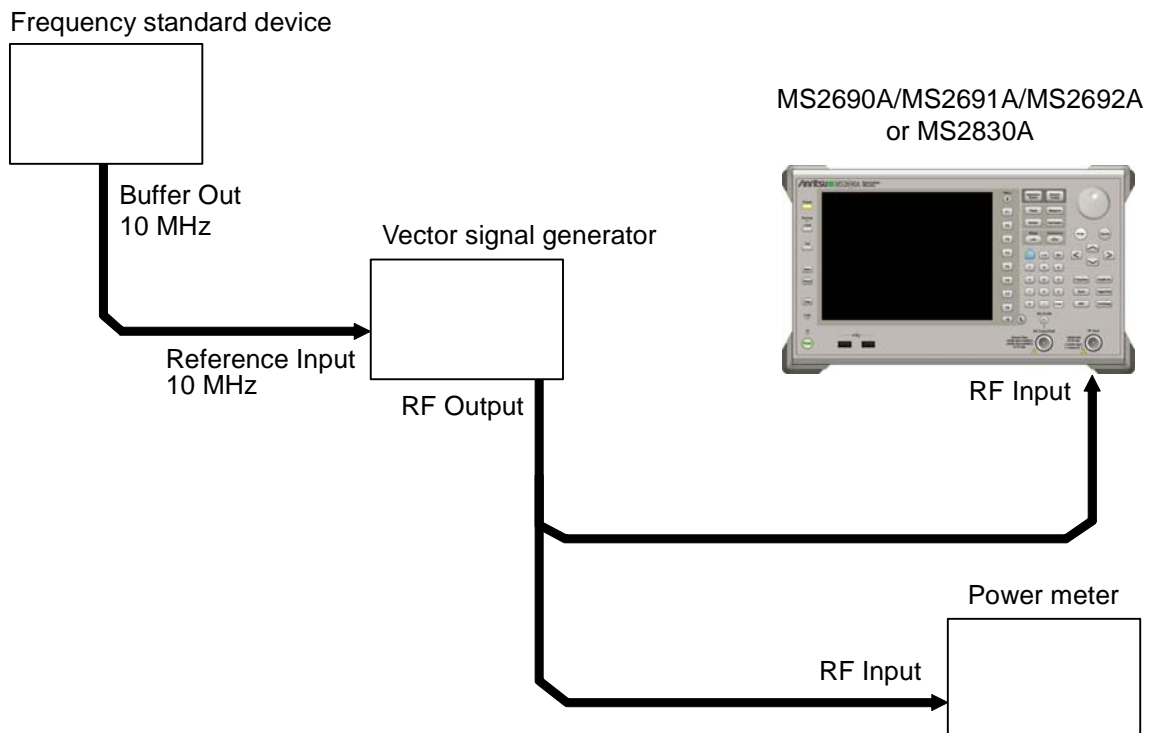





















Figure 5.2.1-1 Performance test

- (4) Test procedure
 - (a) Signal source adjustment
 - 1. Input the 10-MHz reference signal output from the frequency standard device into the Reference Input connector of the vector signal generator.
 - 2. Input the 10 MHz reference signal output from the signal generator to the Reference Input connector.
 - 3. Output an LTE TDD Uplink modulation signal from the vector signal generator.
 - 4. Input the vector signal generator output signal into the power meter and measure the power.
 - (b) Settings of the main unit
 - 1. Turn On the power switch on the front panel then wait until the internal temperature stabilizes (approx. 1.5 hours after the temperature in the thermostatic bath stabilizes).
 - 2. Press , then press the menu function key displaying the character string “LTE-TDD Uplink.”
 - 3. Press .
 - 4. Press  (Preset) to perform initialization.
 - 5. Press .
 - 6. Press  (SIGANA All) to perform calibration.
 - 7. Press  (Close).
 - 8. Press , enter the frequency output by the vector signal generator using the numeric keypad, then press .
 - 9. Press , enter the power meter measurement result using the numeric keypad, then press .
 - 10. Press  then press  (Storage) and press  (Mode) to choose Average using the cursor key or the rotary knob, then press .
 - 11. Press  (Count), enter the measurement count using the numeric keypad, then press .

12. Press  to perform measurement.

When measuring the carrier frequency accuracy, select **Auto** for **Reference Signal**. When measuring the residual vector error, select **Fixed to Internal**.

Press  (System Settings) after pressing  to display the System Settings screen. Select and set Reference Signal with cursor key, and then press  (Set).

13. Confirm whether the measured Frequency Error (carrier frequency accuracy) is within the specifications.
14. Confirm whether the measured EVM (rms) (residual vector error) value is within the specifications.

(5) Test Result

Table 5.2.1-1 Carrier frequency accuracy

Frequency	Min. limit	Deviation (Hz)	Max. limit	Uncertainty	Pass/Fail
400 MHz	MS269xA -8.0 Hz MS2830A -8.0 Hz MS269xA-077/177 /078/178 -8.0 Hz MS2830A-077/177 /078/178 -8.0 Hz		MS269xA +8.0 Hz MS2830A +8.0 Hz MS269xA-077/177 /078/178 +8.0 Hz MS2830A-077/177 /078/178 +8.0 Hz	MS269xA ±0.6 Hz	
1500 MHz				MS2830A ±0.6 Hz	
2700 MHz				MS269xA-077/177 /078/178 ±0.6 Hz	
4000 MHz				MS2830A-077/177 /078/178 ±0.8 Hz	
5000 MHz 3600 MHz (MS2830A-040)				MS269xA ±0.6 Hz MS2830A ±0.9 Hz MS269xA-077/177 /078/178 ±0.6 Hz MS2830A-077/177 /078/178 ±0.8 Hz	

Table 5.2.1-2 Residual vector error

Frequency	Measured value [% (rms)]	Max. limit	Uncertainty	Pass/Fail
400 MHz		MS269xA 1.0%(rms)	MS269xA 0.1%(rms)	
1500 MHz		MS2830A 1.2%(rms)	MS2830A 0.1%(rms)	
2700 MHz		MS269xA-077/177/ 078/178	MS269xA-077/177/ 078/178	
4000 MHz		1.3%(rms)	0.1%(rms)	
5000 MHz 3600 MHz (MS2830A-040)		MS2830A-077/177/ 078/178 1.3%(rms)	MS2830A-077/177/ 078/178 0.1%(rms)	

Chapter 6 Other Functions

This chapter describes other functions of this application.

6.1	Selecting Other Functions	6-2
6.2	Setting Title.....	6-2
6.3	Erasing Warmup Message	6-2

6.1 Selecting Other Functions

Pressing  (Accessory) on the main function menu displays the Accessory function menu.





Table 6.1-1 Accessory function menu

Function Keys	Menu Display	Function
F1	Title	Sets the title character string.
F2	Title (On/Off)	Displays (On) or hides (Off) the title character string.
F4	Erase Warm Up Message	Erases the warmup message display.

6.2 Setting Title

A title of up to 32 characters can be displayed on the screen. (Character strings of up to 17 characters can be displayed on a function menu. The maximum number of characters to be displayed on the top of the function menu varies according to character string.)



<Procedure>

1. Press  (Accessory) on the main function menu.
2. Press  (Title) to display the character string input screen. Select a character using the rotary knob, and enter it by pressing . Enter the title by repeating this operation. When the title is entered, press  (Set).
3. Press  (Title) and then select "Off" to hide the title.

6.3 Erasing Warmup Message

The warmup message , which is displayed upon power-on and indicates that the level and frequency are not stable, can be deleted.

<Procedure>

1. Press  (Accessory) on the main function menu.
2. Press  (Erase Warm Up Message) to erase the warmup message.

Appendix A Error Messages

Table A-1 Error Messages

No.	Message	Description
1	Out of range.	The settable range is exceeded.
2	Not available in Constellation Select.	This operation is invalid when Constellation is selected.
3	Not available in Bottom Graph Select.	This operation is invalid when Bottom Graph is selected.
4	Not available in Averaged over all Subcarriers.	This operation is invalid when Averaged over all Subcarriers is selected.
5	Not available in Averaged over all Symbols.	This operation is invalid when Averaged over all Symbols is selected.
6	Not available in Averaged over all Slots.	This operation is invalid when Averaged over all Slots is selected.
7	Not available in Averaged over all Preamble Sequences.	This operation is invalid when Averaged over all Preamble Sequences is selected.
8	Not available in EVM vs Subcarrier Trace.	This operation is invalid when Active Trace is in the EVM vs Subcarrier state.
9	Not available in EVM vs Symbol Trace.	This operation is invalid when Active Trace is in the EVM vs Symbol state.
10	Not available in Spectral Flatness Trace.	This operation is invalid when Active Trace is in the Spectral Flatness state.
11	Not available in In-band Emission Trace.	This operation is invalid with In-band Emission displayed.
12	Not available in Summary Trace.	This operation is invalid with Summary displayed.
13	Not available in Time Based EVM Trace.	This operation is invalid when Time Based EVM is displayed.
14	Not available in EVM vs Demod-Symbol Trace.	This operation is invalid when EVM vs Demod-Symbol is displayed.
15	Not available in 20MHz Channel Bandwidth.	This operation is invalid when Channel Bandwidth is set to 20 MHz.
16	Not available in 15MHz Channel Bandwidth.	This operation is invalid when Channel Bandwidth is set to 15 MHz.
17	Not available in 10MHz Channel Bandwidth.	This operation is invalid when Channel Bandwidth is set to 10 MHz.
18	Not available in Storage.	This operation is invalid in the Storage state.
19	Please Load Signal Analyzer.	The Signal Analyzer function is required to be loaded.
20	Please Load Spectrum Analyzer.	The Spectrum Analyzer function is required to be loaded.
21	File read error.	File reading has failed.
22	File format error.	The file format is invalid.
23	Write error.	File writing has failed.
24	File Open error.	File Open failed.
25	File Close error.	File Close failed.
26	Empty File Name	No character is entered.
27	Save File Limit < 100	The save destination contains the maximum number of files (100).

Table A-1 Error Messages (Cont'd)

No.	Message	Description
28	Search error	Search error
29	Number of the letters over	This operation is invalid because the maximum number of characters has been exceeded.
30	The model of the main instrument is different	This operation is invalid because the specified model name does not match.
31	The option configuration is different	This operation is invalid because the option configuration does not match.
32	Not available when Capture Time is set to Auto.	This operation is invalid when Capture Time is set to Auto.
33	File not found.	The specified file could not be found.
34	Cannot find device.	The specified device could not be found.
35	Selected item is empty	The selected item (ex. file) could not be found.
36	Not available when Capture Time is Manual and less Capture Time Length.	This operation is invalid when Capture Time is set to Manual and also when Capture Time Length is at minimum value.
37	Only available while replaying.	This operation is invalid when the Replay function is not executed.
38	Shortage of data samples in IQ data file.	Analysis cannot be performed because the number of data samples of the IQ data file is less than the minimum number of data samples required for analysis.
39	Unsupported SpanFrequency. Select the file whose SpanFrequency is 31.25MHz.	The frequency span is not supported.
40	Unsupported SamplingClock.	The sampling rate is not supported.
41	Not available if not re-capture after changing common parameter	This operation is invalid when recapture is not executed after common parameter change.
42	Not available during measurement.	This operation is invalid during measurement.
43	Set any one of the Target Channels to Include.	It is not possible to set all the Target Channels to Exclude. Be sure to set at least one of the Target Channels to Include.
44	Not available when Format is set to 2, 2a or 2b.	The Orthogonal Sequence Index parameter cannot be set when the PUCCH Format is set to 2, 2a, or 2b.
45	Not available when Target Channel PUCCH is set to Include.	This operation cannot be performed when the Target Channel is a PUCCH channel and is set to Include.
46	Not available when Target Channel PRACH is set to Include.	This operation cannot be performed when the Target Channel is a PRACH channel and is set to Include.
47	Not available when Target Channel PUSCH is set to Exclude.	This operation cannot be performed when the Target Channel is a PUSCH channel and is set to Exclude.
48	Not available when Target Channel PUCCH is set to Exclude.	This operation cannot be performed when the Target Channel is a PUCCH channel and is set to Exclude.
49	Not available when Target Channel PRACH is set to Exclude.	This operation cannot be performed when the Target Channel is a PRACH channel and is set to Exclude.
50	Invalid character	—

Table A-1 Error Messages (Cont'd)

No.	Message	Description
51	Not available if not Pre-Amplifier option.	This operation cannot be performed when the Pre-Amplifier option does not exist.
52	Not available if not Vector Signal Generator option.	This operation cannot be performed when the Vector Signal Generator option does not exist.
53	Saving File Open Error.	The file to be saved could not be opened.
54	Not available during Save Captured Data.	This operation cannot be performed during Save Captured Data execution.
55	Not available while executing replay function.	This operation cannot be performed while the replay function is executed.
56	Unsupported IQReverse	The IQReverse is not supported.
57	Unsupported Terminal	The terminal is not supported.
58	It reached the end of waveform data.	–
59	DGZ file error.	Loading IQ data file has failed.
60	Not available when Preamble Format is set to 0.	This operation cannot be performed when the Preamble Format is set to 0.
61	Not available when Preamble Format is set to 1.	This operation cannot be performed when the Preamble Format is set to 1.
62	Not available when Preamble Format is set to 4.	This operation cannot be performed when the Preamble Format is set to 4.
63	Not available when Operating Band Setting is set to Standard.	This operation cannot be performed when Operating Band Setting is set to Standard.
64	Not available when Operating Band Setting is set to User	This operation cannot be performed when Operating Band Setting is set to User.
65	Not available when Standard is set to LTE	This operation cannot be performed when Standard is LTE.
66	Not available when Standard is set to LTE-Adv.	This operation cannot be performed when Standard is LTE-Adv.
67	Not available if not LTE-Advanced option	This operation cannot be performed when the MX269023A-001 LTE-Advanced TDD Uplink Measurement Software is not installed.
68	Not available when Contiguous Mode is set to On	This operation cannot be performed when Contiguous Mode is On.
69	The channel spacing between all CCs shall be multiple of 300 kHz when Contiguous Mode is set to On.	When Contiguous Mode is On, the channel intervals of all CCs (decided by Freq. Offset) must be the multiples of 300 kHz.
70	Not available when Number of CCs is set to 1.	This operation cannot be performed when Number of CCs is 1.
71	Not available when Number of CCs is set to 2.	This operation cannot be performed when Number of CCs is 2.
72	Not available when both CC Statuses are set to On.	This operation cannot be performed when the both CC statuses are On.

Appendix B Default Value List

Frequency

Carrier Frequency	1920 MHz
E-UTRA Operating Band	None
Span	Auto

Amplitude

Input Level	-10.00 dBm
Lowest ATT Setting	4 dB
Pre-Amp	Off
Offset	Off
Offset Value	0.00 dB

Common Setting

Channel Bandwidth	5 MHz
Target Channel	PUSCH
Uplink-downlink configuration	1
Special Subframe Configuration	4
Standard	LTE
Contiguous Mode	On
Number of CCs	2
Synchronization CC#	CC#0
Setting/Result Target CC#	CC#0
In-Band Em. Carr. Leak. Freq.	At Carrier Frequency
CC Status	On
CC Frequency Offset	CC#0: -2400000 CC#1: 2400000

Target Channel PUSCH

Cell ID	0
n_DMRS_2	0
n_DMRS_1	0
Delta SS	0
Sequence Hopping	Off
Group Hopping	On
PUSCH Subframe Assignment	All Checked

Appendix B Default Value List

Target Channel PUCCH

Cell ID	0
N_cs_1	6
N_RB_2	2
n_PUCCH_1	All 0
n_PUCCH_2	0
n_PUCCH_3	All 0
Delta Shift PUCCH	2
Group Hopping	On
PUCCH Subframe Assignment	All Checked

Target Channel PRACH

Configuration Index	51
Physical Root Sequence Number Index	1
Cyclic Shift Value	120

Modulation Analysis

Analysis Time

Starting Subframe Number	2
Starting Slot Number	5
Measurement Interval (Subframe)	8
Measurement Interval (Slot)	62
Measurement Interval Resolution	Subframe
Analysis Frame Position	0 Frame
PUSCH Modulation Scheme	AUTO
PUCCH Format	1
Channel Bandwidth	5 MHz
First RB Number	All 0 RB
Number of RBs	All 25 RB
PRACH Frequency Offset	0
EVM Window Length	W, 32
EVM Window Length(PRACH)	W, 432
EVM Threshold	30.00%
EVM with Exclusion Period	All Checked
Leading Exclusion Period	All 25 μ s
Lagging Exclusion Period	All 25 μ s
BWchannel Selective Filter	Off

Trace (Modulation Analysis)	
Trace Mode	EVM vs Subcarrier
Flatness Type	Amplitude
Emission Type	General & IQ Image
Scale	
EVM Unit	%
EVM Scale	5%
Flatness Scale	-40 dB
Amplitude	± 10 dB
Difference Amplitude	± 1.0 dB
Phase	± 60.0 degree
Group Delay	± 50.0 ns
Storage	
Mode	Off
Count	10
Constellation Symbol Number	28 Symbol
Constellation Preamble Sequence Number	0 Sequence
Bottom Graph Symbol Number	28 Symbol
Bottom Graph Preamble Sequence Number	0 Sequence
Bottom Graph Subcarrier Number	0 Subcarrier
Bottom Graph Slot Number	4 Slot
EVM vs Subcarrier View	Averaged over all Symbols
EVM vs Symbol View	Averaged over all Subcarriers
EVM vs Demod-Symbol View	Averaged over all Symbols
Flatness View	Averaged over all Slots
In-Band Emission View	Averaged over all Slots
Page Number	1
Frame Offset	0
BWchannel Selective Filter	Off

Appendix B Default Value List

Marker (Modulation Analysis)		
Graph Marker		On
Constellation Marker Number		0 Subcarrier 0 Demod-Symbol
Bottom Graph Marker Number		0 Subcarrier 0 Demod-Symbol 0 RB 28 Symbols
Spectral Flatness		
	Difference Amplitude	1 Subcarrier
	Group Delay	1 Subcarrier
Frame Offset		0
Power vs Time		
Channel Bandwidth		5 MHz
First RB		All 0 RB
Number of RBs		All 25 RB
PRACH Frequency Offset		0
EVM Window Length		W, 32
EVM Window Length(PRACH)		W, 432
BWchannel Selective Filter		Off
Trace (Power vs Time)		
Trace Mode		Burst
Scale		
	Reference Level Upper	20 dBm
	Reference Level Lower	-80 dBm
Storage		
	Mode	Off
	Count	10
Marker (Power vs Time)		
Graph Marker		On
Graph Marker Number		61440 Ts

Trigger		
Trigger Switch		Off
Target Channel PRACH		On
Trigger Source		External
Target Channel PRACH		
Video Trigger Level		-40 dBm
Trigger Slope		Rise
Trigger Delay		0 s
Capture		
Capture Time		Auto
Capture Time Length		5 Frame
Save Captured Data		
Device		D:
File Name		Digitize (date)_000
Output Rate		50 MHz
Replay		
Device		D:
Application		LTE-TDD Uplink
Accessory		
Title		On, "LTE-TDD Uplink"

References are to page numbers.

Symbol and Numbers

1

1st Local Output connector 2-7

A

AC inlet..... 2-10

Accessory 6-2

ACP

 FFT..... 3-60

 Swept 3-60

Adjacent Channel Power Measurement

(ACP) 3-60

Amplitude..... 3-9

Analysis Frame Position 3-38

Analysis Time..... 3-35

Anritsu Warranty iii

Applicable parts..... 1-3

Application key..... 2-7

Application Switch 2-12

AUX connector..... 2-9

B

Bottom Graph Marker Number..... 3-66

Bottom Graph Select 3-64

Bottom Graph Sequence Number..... 3-45

Bottom Graph Slot Number 3-45

Bottom Graph Subcarrier Number..... 3-46

Bottom Graph Symbol Number..... 3-45

Buffer Out Connector 2-9

BWchannel Selective Filter..... 3-34

C

Cal key..... 2-3

Calibration..... 2-3

Cancel key 2-6

Capture..... 3-11

Capture Time..... 3-11

Capture Time Length 3-11

Carrier Frequency 3-5

Cautions against computer virus infection .vii

CC Frequency Offset 3-18

CC Status 3-17

CE Conformity Marking..... viii

Cell ID 3-20, 3-22

Channel Bandwidth..... 3-18

Channel Power

 FFT..... 3-61

 Swept..... 3-61

Channel Power Measurement

(Channel Power)..... 3-61

Close 3-113

Common Setting..... 3-14

Composition of Operation Manuals..... I

Configuration Index 3-25

Constellation 3-2, 3-76

Constellation Display Range 3-42

Constellation Marker Number 3-65

Constellation Select..... 3-64

Constellation Sequence Number 3-44

Constellation Symbol Number 3-44

Contiguous Mode..... 3-15

Continuous Measurement 3-4

continuous measurement mode..... 3-4

Copy key 2-3

Count..... 3-43, 3-59

C-Tick Conformity Marking ix

Cursor key 2-6

Cyclic Shift Value 3-26

D

Delta Shift PUCCH 3-24

Delta SS..... 3-21

Demodulation Reference Signal (DMRS) . 3-19

Demodulation Reference Signal (PUCCH)3-22

Demodulation Reference Signal (PUSCH)3-20

Device 3-113

Dip Search 3-69

E

Enter key 2-6

Index

Equipment Certificate iii
Erase Warm Up Message 6-2
Error Messages A-1
Ethernet connector 2-10
Ethernet: 2-4
E-UTRA Operating Band 3-5
EVM (peak)
 Demod-Symbol Number 3-74
 Frame Number 3-74
 Preamble Sequence Number 3-75
 Subcarrier Number 3-74
 Symbol Number 3-74
EVM Display 3-73
EVM Threshold 3-33
EVM vs Demod-Symbol 3-84
EVM vs Demod-Symbol View 3-48
EVM vs Subcarrier 3-79
EVM vs Subcarrier View 3-47
EVM vs Symbol 3-81, 3-82
EVM vs Symbol View 3-47
EVM Window Length 3-57
 Target Channel=PRACH 3-33
 When Target Channel is other than
 PRACH 3-32
EVM Window Length (When Target
Channel is other than PRACH) 3-56
EVM with Exclusion Period 3-33
EVM(peak) 3-74
EVM(rms) 3-74

F

First RB 3-31, 3-55
Flatness View 3-48
 Flatness Type 3-48
Frame Offset 3-46, 3-68
Frequency 3-5
Frequency Error 3-73
Front panel 2-2
Function keys 2-4
Function menu 3-2

G

GPIB 2-4, 2-9
GPIB connector 2-9
Graph Marker 3-64
Graph Marker Number 3-67
Graph window 3-2
Group Hopping 3-21, 3-24

H

Hard disk access lamp 2-3
HDD slot 2-10

I

IF Out connector 2-9
IF output connector 2-10
In-Band Em. Carr. Leak Freq 3-17
In-Band Emission 3-87
In-Band Emission View 3-49
 In-Band Emission Type 3-49
Input Level 3-9

L

Lagging Exclusion Period 3-34
Leading Exclusion Period 3-34
Load Application Select 2-12
Local key 2-4
Lowest ATT Setting 3-9

M

Main function keys 2-5
Marker 3-63
Max Frame Number 3-75
Mean Power 3-74
Measure 3-27
Measurement Interval 3-36
Measurement Interval Resolution 3-37
Measurement parameter 3-2
MKR Amplitude 3-85
MKR Demod-Symbol 3-77, 3-84
MKR Difference Amplitude 3-86
MKR EVM 3-80, 3-81, 3-83, 3-84
MKR Group Delay 3-86

MKR I/Q 3-78
 MKR Phase..... 3-86
 MKR RB 3-88
 MKR Result..... 3-88, 3-111, 3-112
 MKR Slot Number..... 3-86
 MKR Subcarrier 3-77, 3-80, 3-85
 MKR Symbol..... 3-81, 3-83
 MKR Ts..... 3-111, 3-112
 Modulation Analysis..... 3-28
 Modulation control key..... 2-7
 Monitor Out connector 2-10

N

N_cs_1 3-22
 n_DMRS_1..... 3-20
 n_DMRS_2..... 3-20
 n_PUCCH_1 3-23
 n_PUCCH_2 3-23
 n_PUCCH_3 3-24
 N_RB_2..... 3-23
 Next Dip 3-69
 Next Peak 3-68
 Notes On Export Management..... iv
 Number of CCs 3-16
 Number Of RBs 3-32, 3-56
 Numeric keypad 2-6

O

OBW
 FFT..... 3-62
 Swept 3-62
 Occupied Bandwidth Measurement
 (OBW)..... 3-62
 Off Power (After) 3-110
 Off Power (Before) 3-110
 Offset 3-10
 Offset Value 3-10
 On Power 3-110
 Operating Band Highest Frequency..... 3-8
 Operating Band Lowest Frequency..... 3-8
 Operating Band Number..... 3-7
 Operating Band Setting 3-7

Option 1-3
 Origin Offset..... 3-75
 Output Power 3-73

P

Page Number 3-52
 Peak Search..... 3-68
 Performance test..... 5-2
 Physical Root Sequence Number Index.... 3-26
 Power Switch..... 2-3
 Power vs Time 3-53
 Power vs Time Display 3-109
 Power vsTime - Burst 3-111
 Power vsTime - Transient..... 3-112
 PRACH 3-19, 3-25
 PRACH Frequency Offset..... 3-31, 3-55
 Pre-Amp..... 3-9
 Preset key 2-4
 Product Configuration 1-3
 PUCCH Format 3-30, 3-54
 PUCCH-Subframe Assignment 3-24
 PUSCH Modulation Scheme 3-30
 PUSCH Subframe Assignment..... 3-21

R

Rear panel 2-8
 Recall key 2-3
 Ref Input connector 2-9
 reference frequency signal..... 2-9
 Remote lamp..... 2-4
 Replay Function 4-7
 Result window 3-2
 Result Window..... 3-73
 RF Input connector..... 2-6
 RF Output connector 2-7
 RF Output Control key..... 2-6
 Rotary knob 2-6

S

SA Trigger Input connector 2-10
 Save 3-113
 Save key..... 2-3

Index

Saving IQ Data.....	4-2
Saving Measurement Results.....	3-113
Scale	3-42, 3-51, 3-58
Sequence Hopping	3-21
Sequence Number.....	3-77, 3-80
Setting Marker	3-63
Setting Trigger	3-70
Setting/Result Target CC#	3-16
SG Trigger Input connector	2-10
Shift key	2-6
Single Measurement.....	3-4
single measurement mode.....	3-4
Slot Number	3-88
Software End-User License Agreement (EULA)	v
Span.....	3-6
Special subframe configuration.....	3-19
Specifications.....	1-4
Spectral Flatness.....	3-48, 3-85
Spectrum Emission Mask Swept	3-62
Spectrum Emission Mask Measurement (SEM).....	3-62
Standard.....	3-15
Standard configuration	1-3
Starting Slot Number.....	3-36
Starting Subframe Number.....	3-36
Status message.....	3-2
Storage.....	3-43, 3-51, 3-59
Subcarrier Number.....	3-82
Summary	3-89
Sweep Status Out connector	2-9
Symbol Number.....	3-77, 3-80, 3-84
Synchronization CC#.....	3-16
T	
Target Channel.....	3-15
Time Based EVM.....	3-83
Time Offset	3-75
Title	6-2
Title (On/Off)	6-2
Trace	3-39, 3-50, 3-58
Trace (other than Summary)	3-39
Trace Mode	3-41, 3-51, 3-58
Trigger	3-70
Trigger Delay	3-71
Trigger Input connector.....	2-9
Trigger Level.....	3-71
trigger signal	2-9, 2-11
Trigger Slope.....	3-71
Trigger Source	3-70
Trigger Switch	3-70
U	
Uplink-downlink configuration	3-18
USB connector	2-7
Type A.....	2-10
Type B	2-9
Δ	
ΔRB.....	3-88